

BIM

.operate.construct.design.plan

PROJECT EXECUTION PLANNING GUIDE

VERSION 2.0

RELEASED - JULY 2010

<http://www.engr.psu.edu/bim>

A buildingSMART alliance™ Project

Sponsored by

The Charles Pankow Foundation

The Construction Industry Institute

The Pennsylvania State University Office of Physical Plant

The Partnership for Achieving Construction Excellence

Developed by

The Computer Integrated Construction Research Program

at The Pennsylvania State University



CHARLES PANKOW
FOUNDATION

Building Innovation through Research



Construction
Industry
Institute®

PENNSTATE



Office of
Physical Plant



PACE

The Partnership for Achieving Construction Excellence



The Computer Integrated Construction
Research Program

Penn State Department of Architectural Engineering

EXECUTIVE SUMMARY

A Building Information Model (BIM) is “a digital representation of physical and functional characteristics of a facility.”¹ To successfully implement BIM, a project team must perform detailed and comprehensive planning. A well documented BIM Project Execution Plan will ensure that all parties are clearly aware of the opportunities and responsibilities associated with the incorporation of BIM into the project workflow. A completed BIM Project Execution Plan should define the appropriate uses for BIM on a project (e.g., design authoring, cost estimating, and design coordination), along with a detailed design and documentation of the process for executing BIM throughout a project’s lifecycle. Once the plan is created, the team can follow and monitor their progress against this plan to gain the maximum benefits from BIM implementation.

This Guide provides a structured procedure, as displayed in Figure i-1, for creating and implementing a BIM Project Execution Plan. The four steps within the procedure include:

- 1) Identify high value BIM uses during project planning, design, construction and operational phases
- 2) Design the BIM execution process by creating process maps
- 3) Define the BIM deliverables in the form of information exchanges
- 4) Develop the infrastructure in the form of contracts, communication procedures, technology and quality control to support the implementation

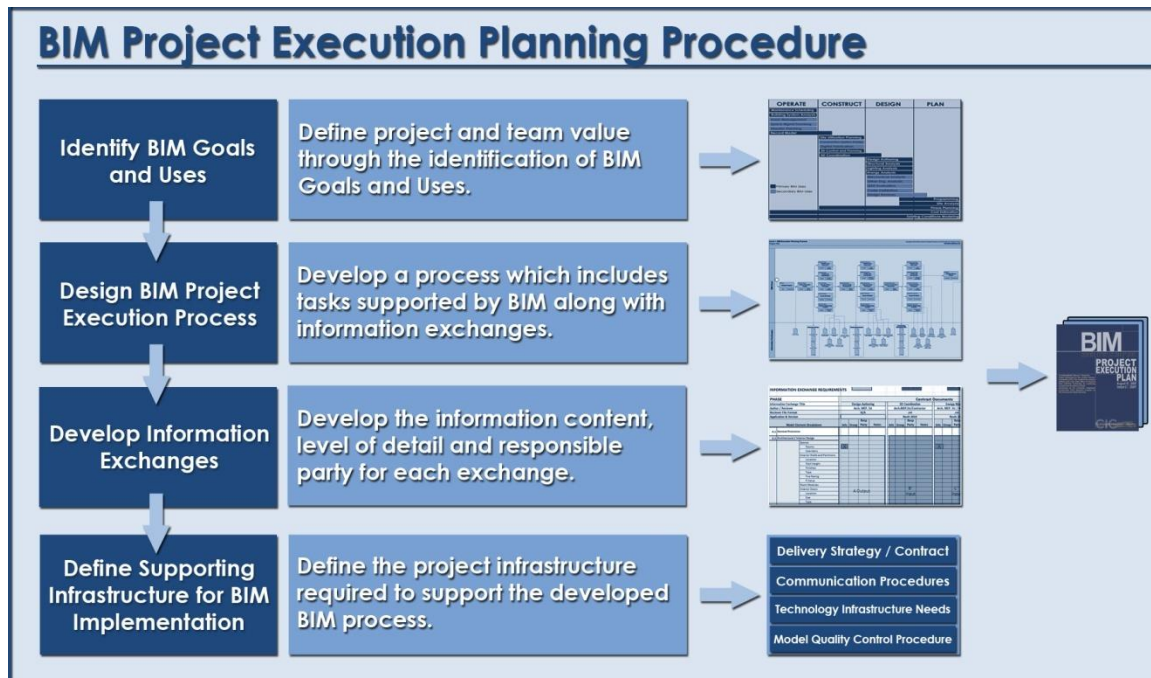

Figure i-1: The BIM Project Execution Planning Procedure

¹ Readers who are not familiar with these concepts should first review the National Building Information Modeling Standard, Part 1 available at <http://www.buildingsmartalliance.org/nbims>.

The goal for developing this structured procedure is to stimulate planning and direct communication by the project team during the early phases of a project. The team leading the planning process should include members from all the organizations with a significant role in the project. Since there is no single best method for BIM implementation on every project, each team must effectively design a tailored execution strategy by understanding the project goals, the project characteristics, and the capabilities of the team members.

This BIM Project Execution Planning Guide is a product of the BIM Project Execution Planning buildingSMART alliance™ (bSa) Project. The bSa is charged with developing the National Building Information Modeling Standard™ (NBIMS). This Guide was developed to provide a practical manual that can be used by project teams to design their BIM strategy and develop a BIM Project Execution Plan. The core modeling and information exchange concepts have been designed to complement the long-term goals of the bSa in the development of a standard that can be implemented throughout the AECOO Industry to improve the efficiency and effectiveness of BIM implementation on projects.

AUTHORS AND CONTRIBUTORS

This Guide was authored by a team of individuals within the Computer Integrated Construction (CIC) Research Program at Penn State. Principle authors of the Guide in alphabetical order include:

- Chimay Anumba, Professor and Head, Department of Architectural Engineering, Penn State
- Craig Dubler, Graduate Research Assistant, Penn State
- Shane Goodman, former MAE/BAE student, Penn State
- Colleen Kasprzak, Graduate Research Assistant, Penn State
- Ralph Kreider, Graduate Research Assistant, Penn State
- John Messner, Director, CIC Research Program and Associate Professor of Architectural Engineering, Penn State
- Chitwan Saluja, former Graduate Research Assistant, Penn State
- Nevena Zikic, former Graduate Research Assistant, Penn State

Contact information for the above authors can be found at the Computer Integrated Construction Research Program website (<http://www.engr.psu.edu/ae/cic/>).

Additional Contributors:

- Project Advisory Board Members (see Acknowledgements)
- Students in the 2008 Penn State AE 597F Graduate Class on BIM Project Execution Planning

Citation for this Document:

Computer Integrated Construction Research Program. (2010). "BIM Project Execution Planning Guide – Version 2.0." July, The Pennsylvania State University, University Park, PA, USA.

Copyright for this Document:

This work is licensed under the Creative Commons Attribution-Share Alike 3.0 United States License. To view a copy of this license, visit <http://creativecommons.org/licenses/by-sa/3.0/us/> or send a letter to Creative Commons, 171 Second Street, Suite 300, San Francisco, California, 94105, USA.

This Building Information Modeling (BIM) Project Execution Planning Guide is directed toward readers with a fundamental understanding of BIM concepts².

The eight chapters in this Guide provide:

- An overview of the BIM Project Execution Planning Procedure (Chapter One)
- A method to identify BIM Uses (Chapter Two)
- A procedure for designing the BIM Process for the project (Chapter Three)
- A method for defining the Information Exchange Requirements (Chapter Four)
- A method to define the infrastructure necessary to support the BIM Process (Chapter Five)
- A structured method for team implementation of the procedure through a series of meetings and intermediate tasks (Chapter Six)
- A structured method for individual organizational development of typical methods for BIM implementation (Chapter Seven)
- Conclusions and Recommendations for projects and organizations implemented BIM based on lessons learned through the creation of the Guide (Chapter Eight)

Appendices provide additional resources for implementing the BIM Project Execution Planning Procedure on a project. These resources include blank template forms for completing each step within the process. There are also example process maps and information exchange examples for a sample project. The sample project used is a hypothetical laboratory project with a limited number of BIM Uses so that it is easy to understand.

Electronic resources are available at the project website (<http://www.engr.psu.edu/bim>). These resources include Microsoft Excel spreadsheets for various template files, a Microsoft Visio file with template process models, and an Adobe PDF template form for completing an execution plan. Project teams can use these documents to develop their BIM Project Execution Plan, or copy appropriate content to any customized organizational documents.

² Readers who are not familiar with these concepts should first review the National Building Information Modeling Standard, Part 1 available at <http://www.buildingsmartalliance.org/nbims>.

ACKNOWLEDGEMENTS

The research team would like to thank the sponsors and project Advisory Board Members for their support of the BIM Project Execution Planning Guide project. The team also wishes to thank the students at Penn State who have contributed to portions of this guide, as well as the industry members who have participated in surveys, interviews and case studies related to the project.

Sponsors:

- The Charles Pankow Foundation (<http://www.pankowfoundation.org>)
- Construction Industry Institute (CII) (<http://www.construction-institute.org>)
- Penn State Office of Physical Plant (OPP) (<http://www.opp.psu.edu>)
- The Partnership for Achieving Construction Excellence (PACE) (<http://www.engr.psu.edu/pace>)

Advisory Board Members:

- Deke Smith, Executive Director of buildingSMART alliance™ (Industry Champion)
- Mark Butler, Chair, US National CAD Standard Project Committee, Systems Integration Manager, and Senior Professional Associate, HDR, Inc.
- Derek Cunz, Director of Project Development, Mortenson Construction
- Mark Falzarano, CAD Coordinator, Barton Malow Company
- Ed Gannon, Manager of Design Services, Penn State Office of Physical Plant
- Greg Gidez, Corporate Design Manager, Hensel Phelps Construction Co.
- Francois Grobler, Ph.D., US Army CERL and IAI - North America
- Steve Hagan, Project Knowledge Center, U.S. General Services Administration
- Steve Hutsell, Chief, Geospatial Section, Seattle District, US Army Corps of Engineers
- Mark Konchar, Vice President, Balfour Beatty Construction
- Soad Kousheshi, President, AEC Strategy
- Robert Leicht, Ph.D., BIM Project Manager, DPR Constructors
- Kurt Maldovan, Design & Construction Visualization Coordinator, Jacobs Global Buildings North America
- Victor Sanvido, Ph.D., Senior Vice President, Southland Industries
- Alexander Zolotov, BIM Technical Lead, Clark Construction Group, LLC

Sponsor Directors:

- Robert Tener, Executive Director, The Charles Pankow Foundation
- Steve Thomas, Associate Director, Construction Industry Institute

TABLE OF CONTENTS

EXECUTIVE SUMMARY	I
AUTHORS AND CONTRIBUTORS	III
READER’S GUIDE	IV
ACKNOWLEDGEMENTS	V
TABLE OF CONTENTS	VII
CHAPTER ONE – OVERVIEW OF THE PROJECT EXECUTION PLANNING PROCEDURE FOR BIM	1
1. Introduction to Building Information Modeling	1
2. Why Should the Project Team Develop a BIM Project Execution Plan?.....	2
3. The BIM Project Execution Planning Procedure	2
4. What Information is Included in a BIM Project Execution Plan?	6
5. Who Should Develop the BIM Plan?	7
6. What Meetings are Needed to Successfully Develop the BIM Plan?	7
7. How Does the BIM Planning Procedure Integrate With the National BIM Standard?	7
CHAPTER TWO – IDENTIFYING BIM GOALS AND USES FOR A PROJECT	9
1. Defining the BIM Goals for the Project	9
2. Description of BIM Uses	10
3. Begin with the End in Mind	11
4. BIM Use Selection Procedure	12
CHAPTER THREE – DESIGNING THE BIM PROJECT EXECUTION PROCESS	15
1. Mapping the Project Execution Process.....	15
2. Creating a BIM Overview Map.....	16
3. Creating a Detailed BIM Use Map.....	19
4. Symbols Used for Process Map Representation	22
CHAPTER FOUR – DEVELOPING INFORMATION EXCHANGES	23
1. Pulling the Information Through the Project.....	23
2. Information Exchange Worksheet	24
CHAPTER FIVE – DEFINE SUPPORTING INFRASTRUCTURE FOR BIM IMPLEMENTATION	27
1. BIM Project Execution Plan Overview	28
2. Project Information.....	28
3. Key Project Contacts	28
4. Project BIM Goals / BIM Uses.....	29
5. Organizational Roles and Staffing.....	29
6. BIM Process Design.....	29
7. BIM Information Exchanges	29
8. BIM and Facility Data Requirements.....	30
9. Collaboration Procedures.....	30
10. Quality Control	31
11. Technology Infrastructure Needs	32
12. Model Structure.....	32
13. Project Deliverables	33
14. Delivery Strategy / Contract	33

1
2
3
4
5
6
7
8

A
B
C
D
E
F
G
H
I
J
K

CHAPTER SIX – IMPLEMENTING THE BIM PROJECT EXECUTION PLANNING PROCEDURE 37

1. Meeting Structure for Developing a BIM Project Execution Plan 37

2. Planning Meeting Schedule 40

3. Monitoring Progress against the BIM Execution Plan 40

CHAPTER SEVEN – BIM PROJECT EXECUTION PLANNING FOR ORGANIZATIONS 41

1. BIM Goals 42

2. BIM Uses 42

3. BIM Process Maps 42

4. BIM Information Exchanges 43

5. BIM Infrastructure 43

6. Developing the BIM Project Execution Plan 44

CHAPTER EIGHT – CONCLUSIONS AND RECOMMENDATIONS FOR BIM PROJECT EXECUTION PLANNING 45

APPENDIX A – BIM GOAL WORKSHEET 47

APPENDIX B – BIM USE DESCRIPTIONS 48

Building (Preventative) Maintenance Scheduling 49

Building Systems Analysis 50

Asset Management 51

Space Management and Tracking 52

Disaster Planning 53

Record Modeling 54

Site Utilization Planning 55

Construction System Design (Virtual Mockup) 56

Digital Fabrication 57

3D Control and Planning (Digital Layout) 58

3D Coordination 59

Design Authoring 60

Engineering Analysis (Structural, Lighting, Energy, Mechanical, Other) 61

Sustainability (LEED) Evaluation 62

Code Validation 63

Design Reviews 64

Programming 65

Site Analysis 66

Phase Planning (4D Modeling) 67

Cost Estimation 68

Existing Conditions Modeling 69

APPENDIX C – BIM USE ANALYSIS WORKSHEET 70

APPENDIX D – TEMPLATE PROCESS MAPS 71

APPENDIX E – LAB EXAMPLE PROCESS MAPS 91

APPENDIX F – INFORMATION EXCHANGE WORKSHEET 99

APPENDIX G – BIM PROJECT EXECUTION PLAN TEMPLATE 101

APPENDIX H – BIM EXECUTION PLANNING CATEGORY GUIDE 119

APPENDIX I – BIBLIOGRAPHY 120

APPENDIX J – GLOSSARY 121

Business Process Mapping Notation (BPMN) Terms and Definitions: 122

APPENDIX K – INDEX 123

1. Introduction to Building Information Modeling

Building Information Modeling (BIM) is a process focused on the development, use and transfer of a digital information model of a building project to improve the design, construction and operations of a project or portfolio of facilities. The National Building Information Modeling Standards (NBIMS) Committee defines BIM as:

“... a digital representation of physical and functional characteristics of a facility. A BIM is a shared knowledge resource for information about a facility forming a reliable basis for decisions during its life-cycle; defined as existing from earliest conception to demolition. A basic premise of BIM is collaboration by different stakeholders at different phases of the life cycle of a facility to insert, extract, update or modify information in the BIM to support and reflect the roles of that stakeholder.”³

When properly implemented, BIM can provide many benefits to a project. The value of BIM has been illustrated through well planned projects which yield: increased design quality through effective analysis cycles; greater prefabrication due to predictable field conditions; improved field efficiency by visualizing the planned construction schedule; increased innovation through the use of digital design applications; and many more. At the end of the construction phase, valuable information can be used by the facility operator for asset management, space planning, and maintenance scheduling to improve the overall performance of the facility or a portfolio of facilities. Yet, there have also been examples of projects where the team did not effectively plan the implementation of BIM and incurred increased costs for the modeling services, schedule delays due to missing information, and little to no added value. Implementing BIM requires detailed planning and fundamental process modifications for the project team members to successfully achieve the value from the available model information.

BIM can be implemented at many phases throughout a project, but the current technology, training, and costs of implementation relative to added value must always be considered when determining the appropriate areas and levels of detail needed in the information modeling processes. Teams should not focus on whether or not to use BIM in general, but instead they need to define the specific implementation areas and uses. A team should aim to implement BIM at the level needed to maximize value while minimizing the cost and impact of the modeling implementation. This requires the team to selectively identify appropriate areas for BIM implementation and plan these implementation areas in detail.

³ NBIMS, 2007 available at http://www.wbdg.org/pdfs/NBIMSv1_p1.pdf.

2. Why Should the Project Team Develop a BIM Project Execution Plan?

To effectively integrate BIM into the project delivery process, it is important for the team to develop a detailed execution plan for BIM implementation. A BIM Project Execution Plan (hereinafter referred to as the 'BIM Plan') outlines the overall vision along with implementation details for the team to follow throughout the project. The BIM Plan should be developed in the early stages of a project; continually developed as additional participants are added to the project; and monitored, updated, and revised as needed throughout the implementation phase of the project. The plan should define the scope of BIM implementation on the project, identify the process flow for BIM tasks, define the information exchanges between parties, and describe the required project and company infrastructure needed to support the implementation.

By developing a BIM Plan, the project and project team members can achieve the following value:

1. All parties will clearly understand and communicate the strategic goals for implementing BIM on the project
2. Organizations will understand their roles and responsibilities in the implementation
3. The team will be able to design an execution process which is well suited for each team member's business practices and typical organizational workflows
4. The plan will outline additional resources, training, or other competencies necessary to successfully implement BIM for the intended uses
5. The plan will provide a benchmark for describing the process to future participants who join the project
6. The purchasing divisions will be able to define contract language to ensure that all project participants fulfill their obligations
7. The baseline plan will provide a goal for measuring progress throughout the project.

BIM, like other new technologies, can carry some level of additional process risk when implemented by teams that are not experienced with the implementation process, or if people are not familiar with the strategies and processes of their team members. Ultimately, the entire team will gain value through the increased level of planning by reducing the unknowns in the implementation process thereby reducing the overall risk to all parties and the project.

3. The BIM Project Execution Planning Procedure

This guide outlines a four step procedure to develop a detailed BIM Plan. The procedure is designed to steer owners, program managers, and early project participants through a structured process to develop detailed, consistent plans for projects. This procedure was developed through a multi-step research process which included industry interviews with over 40 industry experts, detailed analysis of existing planning documents, focus group meetings with industry participants, process mapping research to design an efficient and effective mapping structure, and case study research to validate the procedure.

The four steps, shown in Figure 1-1, consist of identifying the appropriate BIM goals and uses on a project, designing the BIM execution process, defining the BIM deliverables, and identifying the supporting infrastructure to successfully implement the plan. These steps are introduced in the following sections, and then a chapter in this guide is dedicated to explaining the details related to each step. Detailed templates have also been created to support each of these steps. These templates are available on the project website as well as the printed examples included in the Appendices of this guide.

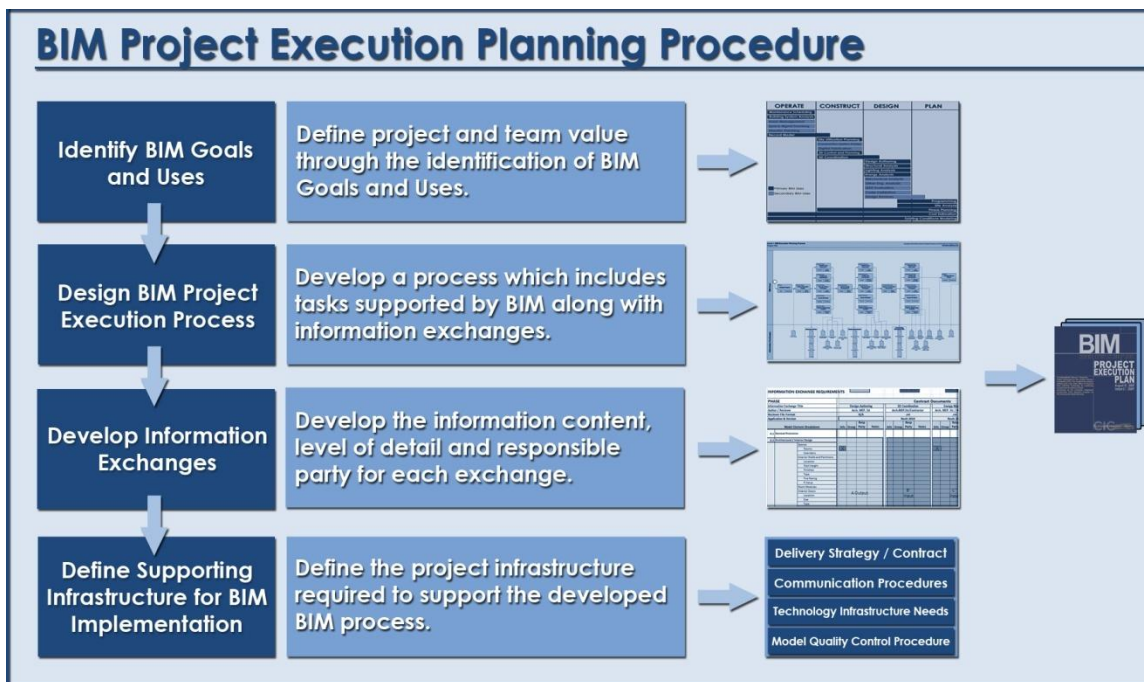

Figure 1-1: The BIM Project Execution Planning Procedure

Identify BIM Goals and Uses

One of the most important steps in the planning process is to clearly define the potential value of BIM on the project and for project team members through defining the overall goals for BIM implementation. These goals could be based on project performance and include items such as reducing the schedule duration, achieving higher field productivity, increasing quality, reducing cost of change orders, or obtaining important operational data for the facility. Goals may also relate to advancing the capabilities of the project team members, for example, the owner may wish to use the project as a pilot project to illustrate information exchanges between design, construction and operations or a design firm may seek to gain experience in the efficient use of digital design applications. Once the team has defined measurable goals, both from a project perspective and company perspective, then the specific BIM uses on the project can be identified.

The guide includes twenty-five common uses for BIM which have been identified through analysis of project case studies, interviews with industry experts, and review of literature. A BIM Use is a unique task or procedure on a project which can benefit from the integration of BIM into that process. The twenty-five identified uses are not comprehensive, but provide a good representation of the current uses of BIM within the industry. Several examples of BIM Uses include design authoring, 4D modeling, cost estimating, space management and record modeling. The team should identify and prioritize the appropriate BIM Uses which they have identified as beneficial to the project. The procedure for identifying BIM Goals and Uses is discussed in further detail in Chapter Two of this guide.

Design the BIM Execution Process

Once the team has identified the BIM Uses, a process mapping procedure for planning the BIM implementation needs to be performed. Initially, a high level map showing the sequencing and interaction between the primary BIM Uses on the project is developed (see Figure 1-2). This allows all team members to clearly understand how their work processes interact with the processes performed by other team members.

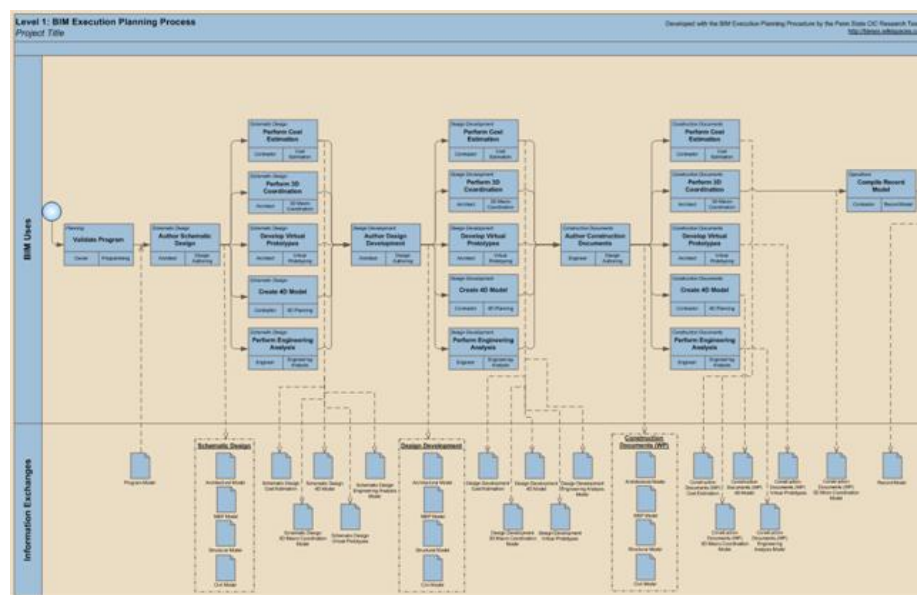

Figure 1-2: High Level BIM Use Map (see Chapter 3 for full size image)

After the high level map is developed, then more detailed process maps should be selected or designed by the team members responsible for each detailed BIM Use. For example, the high level map will show how the BIM authoring, energy modeling, cost estimating, and 4D modeling are sequenced and interrelated. A detailed map will show the detailed process that will be performed by an organization or, in some cases, several organizations, such as may be the case for energy modeling. The procedure for designing the BIM execution process is discussed in further detail in Chapter 3 of this guide.

Develop Information Exchanges

Once the appropriate process maps have been developed, the information exchanges which occur between the project participants should be clearly identified. It is important for the team members, in particular the author and receiver for each information exchange transaction, to clearly understand the information content. This information content for the exchange can be defined in the Information Exchange table a portion of which is displayed as an example in Figure 1-3. The procedure for defining the information exchanges is discussed in further detail in Chapter Four of this guide.

INFORMATION EXCHANGE WORKSHEET

Information		Responsible Party	
A	Accurate Size & Location, include materials and object parameters	A	Architect
		C	Contractor
B	General Size & Location, include parameter data	CV	Civil Engineer
		FM	Facility Manager
		MEP	MEP Engineer
C	Schematic Size & Location	SE	Structural Engineer
		TC	Trade Contractors

Information Exchange Title	Record Modeling			4D Modeling			3D Coordination			Design Authoring					
Time of Exchange (SD, DD, CD, Construction)	Construction			CD			CD			CD					
Model Receiver	FM			C			C, TC			ALL					
Receiver File Format															
Application & Version															
Model Element Breakdown				Info	Resp Party	Additional Information	Info	Resp Party	Notes	Info	Resp Party	Notes	Info	Resp Party	Notes
A	SUBSTRUCTURE														
	Foundations														
		Standard Foundations													
		Special Foundations													
		Slab on Grade													
	Basement Construction														
		Basement Excavation													
		Basement Walls													
B	SHELL														
	Superstructure														
		Floor Construction													
		Roof Construction													
	Exterior Enclosure														
		Exterior Walls													
		Exterior Windows													
		Exterior Doors													
	Roofing														
		Roof Coverings													
		Roof Openings													
C	INTERIORS														
	Interior Construction														
		Partitions													
		Interior Doors													
		Fittings													
	Stairs														
		Stair Construction													

Figure 1-3: Portion of the Information Exchange Spreadsheet template

Define Supporting Infrastructure for BIM Implementation

After the BIM uses for the project have been identified, the project process maps are customized, and the BIM deliverables are defined, the team must develop the infrastructure needed on the project to support the planned BIM process. This will include the definition of the delivery structure and contract language; defining the communication procedures; defining the technology infrastructure; and identifying quality control procedures to ensure high quality information models. The procedure for defining the infrastructure along with methods to implement and track progress is discussed in further detail in Chapter 5 of this guide.

4. What Information is Included in a BIM Project Execution Plan?

When complete, the BIM Plan should address the following categories of information:

1. **BIM Project Execution Plan Overview Information:** Document the reason for creating the Project Execution Plan.
2. **Project Information:** The Plan should include critical project information such as project numbers, project location, project description, and critical schedule dates for future reference.
3. **Key Project Contacts:** As part of the reference information, A BIM Plan should include contact information for key project personnel.
4. **Project Goals / BIM Objectives:** This section should document the strategic value and specific uses for BIM on the project as defined by the project team in the initial step of the planning procedure. Additional information regarding this category is included in Chapter Two.
5. **Organizational Roles and Staffing:** One of the primary tasks is to define the coordinator(s) of the BIM planning and execution process throughout the various stages of the project. This is particularly important when identifying the organization(s) who will initiate the development of the BIM Plan, as well as the required staff to successfully implement the plan.
6. **BIM Process Design:** This section should clearly illustrate the execution process through the use of process maps which are developed in the second step of the planning procedure. Additional information regarding this category is included in Chapter Three.
7. **BIM Information Exchanges:** The model elements and level of detail required to implement each BIM Use should be clearly defined in the information exchanges requirements. Additional information regarding this category is included in Chapter Four.
8. **BIM and Facility Data Requirements:** The owner's requirements for BIM must be documented and understood.
9. **Collaboration Procedures:** The team should develop their electronic and collaboration activity procedures. This includes the definition of model management procedures (e.g., file structures, and file permissions) as well as typical meeting schedules and agendas.
10. **Model Quality Control Procedures:** A procedure for ensuring that the project participants meet the defined requirements should be developed and monitored throughout the project.
11. **Technology Infrastructure Needs:** The hardware, software and network infrastructure required to execute the plan should be defined.
12. **Model Structure:** The team should discuss and document items such as model structure, file naming structure, coordinate system, and modeling standards.
13. **Project Deliverables:** The team should document deliverables required by the owner.
14. **Delivery Strategy / Contracts:** This section should define the delivery strategy which will be used on the project. The delivery strategy, e.g., design-build vs. design-bid-build, will impact implementation and it will also impact the language which should be incorporated into the contracts to ensure successful BIM implementation.

Note: These items are discussed in further detail in Chapter 5 of this guide.

5. Who Should Develop the BIM Plan?

To develop the BIM Plan, a planning team should be assembled in the early stages of a project. This team should consist of representatives from all the primary project team members including the owner, designers, contractors, engineers, major specialty contractors, facility manager, and project owner. It is very important for the owner, as well as, all primary team members to fully support the planning process. For the initial goal setting meetings, key decision-makers should be represented from each of the organizations so that the overall goals and vision for implementation on the project are clearly defined for further planning initiatives. Once this initial goal setting is complete, then the detailed implementation processes and information exchanges can be developed and implemented by the lead BIM coordinators for each of the parties.

The lead party for coordinating and compiling the BIM Plan should be clearly identified. This role may vary based on the project delivery method, the timing of the BIM Plan development, and the expertise of the participants. Parties who may lead this planning initiative could include the owner, architect, program manager, or construction manager. For some projects, it may be beneficial to have an initial party start the planning, e.g., the owner may begin the planning prior to contracting with additional parties for their services, and then the BIM Plan may be transitioned and completed by another party, such as the construction manager or architect. In some circumstances, it may be beneficial to contract with a third party to facilitate the planning procedure if the team is inexperienced or the team finds it beneficial to have a facilitator for the planning activities.

6. What Meetings are Needed to Successfully Develop the BIM Plan?

The BIM Plan for the project cannot be developed in isolation. No one party within the project team can adequately outline the execution plan, while also obtaining the necessary team member commitments for successful BIM implementation. In order to have a successful project using BIM, full coordination and collaboration by all parties is an absolute necessity. The planning team should conduct a series of planning meetings to develop the execution plan. On most projects a minimum of two or three meetings will be needed to develop the overall BIM Plan. The initial meeting will need to have key decision makers for all organizations. Follow-up meetings will require fewer people, and be more targeted on the details related to execution. A detailed outline of a series of four meetings for developing the BIM Plan is included in Chapter 6 of this guide and includes template agendas and interim activities to be performed by the planning team.

7. How Does the BIM Planning Procedure Integrate With the National BIM Standard?

The National Building Information Modeling Standard™ (NBIMS) is currently being developed by the buildingSMART alliance™, a part of the National Institute for Building Sciences. The goal of the NBIMS is to identify and define standard information exchanges that are required on facility projects. The BIM Plan Procedure is designed to complement the standard exchange requirements under development in

the NBIMS initiative. Ultimately, the vision will be that a project team can seamlessly integrate the information exchanges in the NBIMS with step 3 of this execution planning procedure which focuses on Information Exchange Requirements. As the information exchanges become standard throughout the industry, the third step of this process could be simplified by referencing the standard exchanges, instead of providing a custom information exchange requirement for a task.

The BIM Plan Procedure will also be submitted for potential acceptance as a standard procedure for creating BIM Project Execution Plans for incorporation into the NBIMS. If the industry standardizes the procedure for planning the BIM Execution on projects, then organizations can create their typical company workflows and procedures in a format to easily integrate with the BIM Plan Procedure. This will make it easier for teams to quickly plan the execution strategy on a project. If all organizations map their standard processes, then the project execution planning procedure is a design task which compiles the different work processes from the various team members (see Figure 1-4). It will also make it easier for team members including the owner to quickly and effectively understand and evaluate execution plans since they will be organized in a standard format with consistent information.

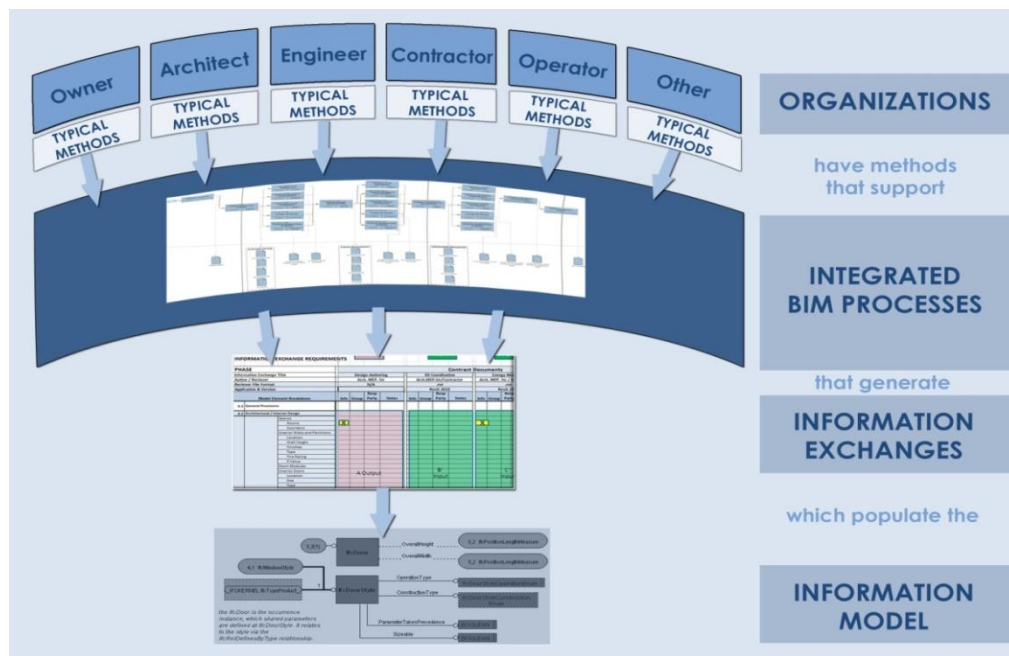

Figure 1-4: The BIM Project Execution Planning Concept

The first step in developing a BIM Project Execution Plan is to identify the appropriate BIM Uses based on project and team goals. A current challenge and opportunity faced by the early project planning team is identifying the most appropriate uses for BIM on a project given the project characteristics, participants' goals and capabilities, and the desired risk allocations. There are many different tasks which can benefit from the incorporation of BIM. These benefits are documented as BIM Uses, and this guide includes twenty-five uses for consideration on a project (see Figure 2-1). The goal of this chapter is to provide a method for identifying appropriate BIM Uses for project implementation.

PLAN	DESIGN	CONSTRUCT	OPERATE
Existing Conditions Modeling			
Cost Estimation			
Phase Planning			
Programming			
Site Analysis			
Design Reviews			
Design Authoring			
Energy Analysis			
Structural Analysis			
Lighting Analysis			
Mechanical Analysis			
Other Eng. Analysis			
LEED Evaluation			
Code Validation			
3D Coordination			
Site Utilization Planning			
Construction System Design			
Digital Fabrication			
3D Control and Planning			
Record Model			
Maintenance Scheduling			
Building System Analysis			
Asset Management			
Space Mgmt/Tracking			
Disaster Planning			

Primary BIM Uses
 Secondary BIM Uses

Figure 2-1: BIM Uses throughout a Building Lifecycle
(organized in chronological order from planning to operation)

1. Defining the BIM Goals for the Project

Prior to identifying BIM Uses, the project team should outline project goals related as to BIM. These project goals should be specific to the project at hand, measureable, and strive to improve the successes of the planning, design, construction and operations of the facility. One category of goals should relate to general project performance including reducing the project schedule duration, reducing the project cost, or increasing the overall quality of the project. Examples of quality goals include the development of a more energy efficient design through the rapid iteration of energy modeling, creating higher quality installed designs through detailed 3D coordination of systems, or developing more accurate record models to improve the quality of performance modeling and commissioning.

Other goals may target the efficiency of specific tasks to allow for overall time or cost savings by the project participants. These goals include the use of modeling applications to create design documentation more efficiently, to develop estimates through automated takeoffs, or to reduce the time to enter data into the maintenance system. These items are only suggestions of potential goals that the project team may have when beginning to decide how to implement BIM on a project. It is by no means a comprehensive list and it is essential to identify the specific goals that will provide incentive for implementing BIM on the project.

A hypothetical new Laboratory Building constructed on a university campus will be used throughout the following three chapters to illustrate the steps in the guide. Sample project goals from this example project are shown in Table 2-1. Additionally, a blank BIM Goal Worksheet can be found in Appendix A.

Table 2.1 – Sample BIM Goals for a Laboratory Building Project

Priority (1-3)	Goal Description	Potential BIM Uses
1 - Most Important	Value added objectives	
2	Increase Field Productivity	Design Reviews, 3D Coordination
3	Increase effectiveness of Design	Design Authoring, Design Reviews, 3D Coordination
1	Accurate 3D Record Model for FM Team	Record Model, 3D Coordination
1	Increase effectiveness of Sustainable Goals	Engineering Analysis, LEED Evaluation
2	Track progress during construction	4D Modeling
3	Identify concerns associated with phasing on campus	4D Modeling
1	Review Design progress	Design Reviews
1	Quickly Assess cost associated with design changes	Cost Estimation
2	Eliminate field conflicts	3D Coordination

It is important to understand that some goals may relate to specific uses while other goals may not. For example, if there is a project goal to increase field labor productivity and quality through large amounts of prefabrication, then the team can consider the ‘3D Design Coordination’ BIM Use which will allow the team to identify and correct potential geometric conflicts prior to construction. On the other hand, if the team’s goal was to increase the sustainability of the building project, several uses may assist in accomplishing that goal.

2. Description of BIM Uses

Twenty-five BIM Uses, organized by project phase of project development, were identified through numerous interviews with industry experts, analysis of implementation case studies, and review of literature (reference Figure 2-2). A one-page summary level description of each of these BIM Uses is included in Appendix B of this guide and is available on the BIM Execution Project website.⁴ The descriptions were developed to provide a brief overview for project team members who may not be familiar with the BIM Use, and to provide additional information that the project team may find valuable

⁴ BIM Execution Planning Guide Website available at: <http://www.engr.psu.edu/ae/cic/bimex/>

during the selection process. Each description includes an overview of the BIM Use, potential benefits, required team competencies, and selected resources that can be referenced for additional information about the BIM Use. An example of a BIM Use description is shown below in Figure 2-3.

Cost Estimation	
Description:	A process in which a BIM model can offer a reasonable accurate quantity take-off and cost estimate early in the design process and provide cost effects of additions and modifications with potential to save time and money and avoid budget overruns. This process also allow designers to see the cost effects of their changes in a timely manner which can help curb excessive budget overruns due to project modifications.
Potential Value: (improvements in project / process)	<ul style="list-style-type: none"> • Precisely estimate material quantities and generate quick revisions if needed • Stay within budget constraints with frequent preliminary cost estimates while the design progresses • Better visual representation of project and construction elements that need to be estimated: taken off and priced • Provide cost information to the owner during the early decision making phase of design • Focus on more value adding activities in estimating like identifying construction assemblies, generating pricing and factoring risks then quantity take-off, which are essential for high quality estimates • Exploring different design options and concepts within the owner's budget • Saving estimator's time and allowing to focus on more important issues in an estimate since take-offs can be automatically provided • Quickly be able to determine costs of specific objects
Resources Required:	<ul style="list-style-type: none"> • Model-based Estimating Software • Design Authoring Software • Cost Data
Competencies Required:	<ul style="list-style-type: none"> • Ability to define specific design modeling procedures which yield accurate quantity take-off information

Figure 2-2: Typical BIM Use Description
(see Appendix B for full descriptions)

3. Begin with the End in Mind

For BIM to be implemented successfully, it is critical that team members understand the future use of the information that they are developing. For example, when an architect adds a wall to the architectural model, that wall may carry information regarding the material quantities, mechanical properties, structural properties and other data attributes. The architect needs to know if this information will be used in the future, and if so, how it will be used. The future use of this data can frequently impact the methods used to develop the model, or identify quality control issues related to the data accuracy for tasks relying on the information.

To emphasize the lifecycle of the information, a core concept of the BIM Plan Procedure is to identify the appropriate uses of BIM by beginning with the potential end-uses of the information in the model. To do so, the project team should first consider the later phases of a project to understand what information will be valuable to have during that phase. Then, they can move back through all of the project phases in reverse order (Operations, Construction, Design, and then Planning) as in Figure 2-2. This perspective to 'begin with the end in mind' will identify the downstream desired uses of

information which should be supported by earlier processes in the lifecycle of the project. By identifying these downstream BIM uses first, the team can focus on identifying reusable project information and important information exchanges.

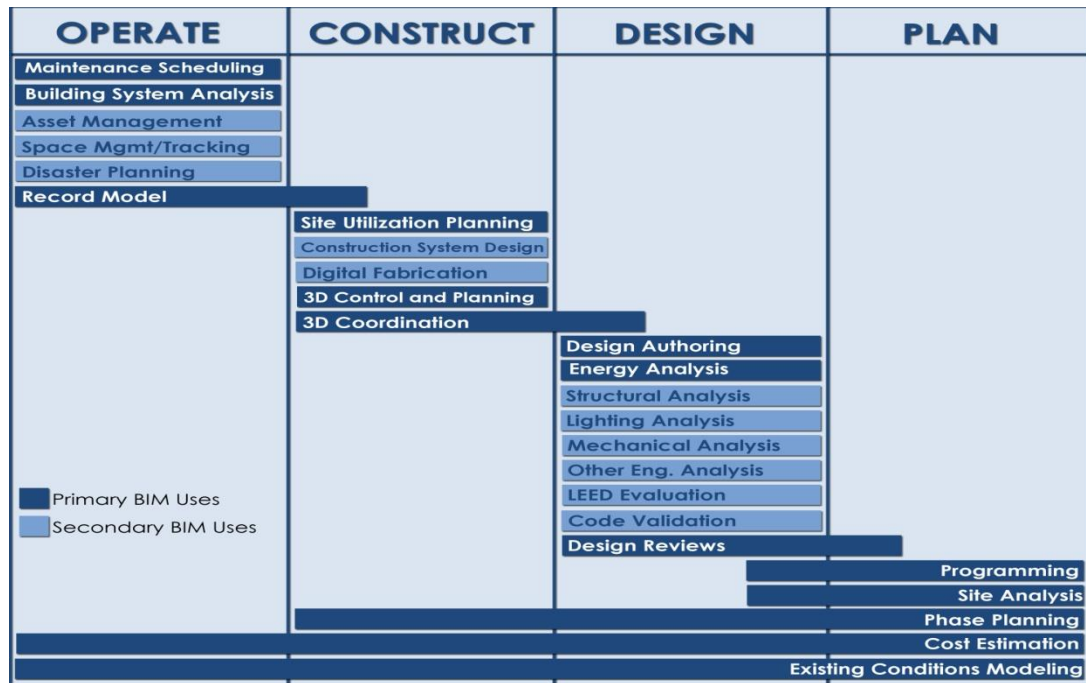

Figure 2-3: BIM Uses throughout a Building Lifecycle
(organized in reverse chronological order from project implementation)

4. BIM Use Selection Procedure

Once the goals are defined, the project team should identify the appropriate tasks that the team would like to perform using BIM. This analysis of BIM Uses should initially focus on the desired outcomes for the overall process. Therefore, the team should begin with the Operations phase, and identify the value for each of the BIM Uses as it specifically relates to the project by providing a High, Medium or Low priority to each use. The team can then progress to each preceding project phase (Construction, Design and Planning).

To help facilitate this BIM Use review process, a BIM Selection Worksheet has been developed. This template includes a list of the potential BIM Uses, along with fields to review the value, responsible party, capabilities, additional notes, and the decision from the team on whether to implement the BIM Use. Please reference Figure 2-4 for an example of the BIM Selection Worksheet on the example Laboratory Project.

BIM Use*	Value to Project	Responsible Party	Value to Resp Party	Capability Rating	Additional Resources / Competencies Required to Implement	Notes	Proceed with Use
	High / Med / Low		High / Med / Low	Scale 1-3 (1 = Low)			YES / NO / MAYBE
				Resources Competency Experience			
Record Modeling	HIGH	Contractor	MED	2 2 2	Requires training and software		YES
		Facility Manager	HIGH	1 2 1	Requires training and software		
		Designer	MED	3 3 3			
Cost Estimation	MED	Contractor	HIGH	2 1 1			NO
4D Modeling	HIGH	Contractor	HIGH	3 2 2	Need training on latest software Infrastructure needs	High value to owner due to phasing complications	YES
						Use for Phasing & Construction	
3D Coordination (Construction)	HIGH	Contractor	HIGH	3 3 3			YES
		Subcontractors	HIGH	1 3 3	conversion to Digital Fab required	Modeling learning curve possible	
		Designer	MED	2 3 3			
Engineering Analysis	HIGH	MEP Engineer	HIGH	2 2 2			MAYBE
		Architect	MED	2 2 2			
Design Reviews	MED	Arch	LOW	1 2 1		Reviews to be from design model no additional detail required	NO
3D Coordination (Design)	HIGH	Architect	HIGH	2 2 2	Coordination software required	Contractor to facilitate Coord.	YES
		MEP Engineer	MED	2 2 1			
		Structural Engine	HIGH	2 2 1			
Design Authoring	HIGH	Architect	HIGH	3 3 3			YES
		MEP Engineer	MED	3 3 3			
		Structural Engine	HIGH	3 3 3			
		Civil Engineer	LOW	2 1 1	Large learning curve	Civil not required	
Programming	MED					Planning Phase Complete	NO

* Additional BIM Uses as well as information on each Use can be found at <http://www.engr.psu.edu/ae/cic/bimex/>

Figure 2-4: BIM Use Selection Worksheet Example (Partial List – See Appendix F – Information Exchange Worksheet for full information exchange worksheet)

BIM Use Selection Worksheet Completion Procedure

To complete the BIM Use Selection Worksheet, the team should proceed through the following steps with key project stakeholders. (See Chapter Six for details about meeting structure.)

1. Identify the potential BIM Uses

Definitions and explanations for each BIM Use are available by project phase in Appendix B as well as the BIM Execution Planning Website⁵. It is important that the team consider each of potential uses and consider their relationship with the project goals.

2. Identify the responsible parties for each potential BIM Use

For each use that is being considered, at least one responsible party should be identified. The responsible parties include any team members who will be involved in the use if it is performed,

⁵ BIM Execution Planning Guide Website available at: <http://www.engr.psu.edu/ae/cic/bimex/>

along with potential outside participants that may be needed to assist with the implementation. List the lead responsible party first in the spreadsheet.

3. Rate the capabilities of each party for each BIM use identified in the following categories

a. Resources⁶ – Does the organization have the resources necessary to implement the BIM Use required? Some of the general resources required include:

- Personnel - BIM Team
- Software
- Software Training
- Hardware
- IT support

b. Competency⁷ – Does the responsible party have the know-how to successfully implement the specific BIM use? To determine competency, the project team should understand the details for the BIM use and how it will be carried out on the specific project.

c. Experience - Has the responsible party performed the Use of BIM in the past? The team experience associated with each BIM Use is vital to the success of implementation.

4. Identify additional value and risk associated with each Use

The team should consider the potential value gained, as well as, additional project risk that may be incurred by proceeding with each BIM Use. These value and risk elements should be incorporated into the 'notes' column of the BIM Use Selection Worksheet.

5. Determine whether or not to implement each BIM Use

The team should discuss each BIM Use in detail to determine whether or not the BIM Use is appropriate for the project given its characteristics (both project and team). This will require that the team determine the potential added value or benefit to the project and then compare this potential benefit to the cost of implementation. The team will also need to consider the risk elements associated with implementing or not implementing each particular BIM Use. For example, some BIM Uses can significantly reduce overall project risk, however they may shift risk from one party to another. In other situations, the implementation of a BIM Use may potentially add risk for a party when they successfully perform their scope of work. Once all factors are considered, the team needs to make a 'go / no go' decision related to each BIM Use. Also understand that as the team decides to perform several BIM Uses, others may become easier to implement because the team members can leverage existing information. For example, if the architectural design is authored in a 3D parametric modeling application, then it is less expensive to implement 3D design coordination

⁶ Specific resources and competencies associated with successful implementation can be found under the description of each BIM Use in Appendix B or the project website.

⁷ Specific resources and competencies associated with successful implementation can be found under the description of each BIM Use in Appendix B or the project website.

After each BIM Use is identified, it is necessary to understand the implementation process for each BIM Use and the implementation process of the project as a whole. This chapter describes a procedure to design the BIM Project Execution Process. The process map developed in this step allows the team to understand the overall BIM process, identify the information exchanges that will be shared between multiple parties, and clearly define the various processes to be performed for the identified BIM Uses. The use of process mapping techniques allows the team to effectively perform this step. These process maps will also serve as the basis for identifying other important implementation topics including contract structure, BIM deliverable requirements, information technology infrastructure, and selection criteria for future team members.

1. Mapping the Project Execution Process

Mapping the BIM Process for the project requires the project team to first develop an overview map which shows how the different BIM Uses will be performed. Then, detailed BIM Use Process Maps are developed to define the specific BIM implementation at an increased level of detail. To implement this two-level approach, Business Process Modeling Notation (BPMN)⁸ has been adopted so that consistently formatted process maps will be created by the various project team members.

Level 1: BIM Overview Map

The Overview Map shows the relationship of BIM Uses which will be employed on the project. This process map also contains the high level information exchanges that occur throughout the project lifecycle.

Level 2: Detailed BIM Use Process Maps

Detailed BIM Use Process Maps are created for each identified BIM Use on the project to clearly define the sequence of various processes to be performed. These maps also identify the responsible parties for each process, reference information content, and the information exchanges which will be created and shared with other processes.

⁸ For more information on BPMN, please refer to <http://www.bpmn.org/>

2. Creating a BIM Overview Map

This section details out how to create a BIM Overview Map.

3

1) *Place potential BIM Uses into a BIM Overview Map*

Once the team identifies the BIM Uses for the project (refer to the BIM Use Selection Worksheet from Chapter Two), the team can start the mapping process by adding each of the BIM Uses as a process within the map. It is important to understand that a BIM Use may be added to the overview map at several locations if it is performed at several times within the project lifecycle.

To help achieve this task, a template Microsoft Visio file containing process maps is published at the BIM Project Execution Planning Guide Website⁹. A Microsoft Visio Stencil file is also posted in the same location and can be used by the project team to easily develop the process maps. If the project team members do not have Microsoft Visio, the team could use other process mapping or graphics software to development the process maps. Additionally, versions of the templates are in Appendix D – Template Process Maps.

2) *Arrange BIM Uses according to project sequence in the BIM Overview Map*

After the project team has established the BIM processes that will be implemented on the project, the team should sequentially order these processes. One of the purposes of the Overview Map is to identify the phase for each BIM Use (e.g., Planning, Design, Construction or Operation) and provide the team with the implementation sequence. For simplistic purposes, the BIM Uses should be aligned with the BIM deliverables schedule.

3) *Identify the responsible parties for each process*

Responsible Parties should be clearly identified for each process. For some processes, this may be an easy task, but for others it may not. It is important in all cases to consider which team member is best suited to successfully complete the task. Additionally some processes may have multiple responsible parties. The identified party will be responsible for clearly defining the information required to implement the process as well as the information produced by the process.

The graphical notation and information format for the processes within the BIM Overview Map are included in Figure 3-1. Each process should include a process name, project phase, and the responsible party. Each process should also include a 'Detailed Map' title which points to the detailed map (Level Two map) for the process. This detailed map notation is used since several processes may share the same detailed map. For example, a construction management company may perform cost estimating from the building information provided from the designer. The Construction manager may perform this estimate during the schematic design, design development and construction document phase, but it may utilize the same detailed

⁹ BIM Execution Planning Guide Website available at: <http://www.engr.psu.edu/ae/cic/bimex/>

workflow to accomplish this task, which can be represented in a single detailed map. Therefore, the process for performing the three estimates would be added into the high level map at three locations, but the team could reference a single detailed map for further information.

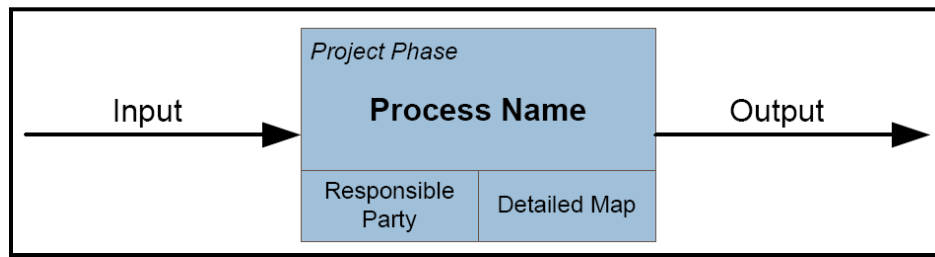

Figure 3-1: Notation for a Process in the Overview Process Map

4) Determine the Information Exchanges required to implement each BIM Use

The BIM Overview Map includes the critical information exchanges which are either internal to a particular process or shared between processes and responsible parties. In general, it is important to include all information exchanges that will pass from one party to another. In current applications, these exchanges are typically implemented through the transfer of a data file, although it could also include the entry of information into a common database. All the information exchanges identified in the BIM Overview Map should be detailed as defined in Chapter Four.

The exchanges which originate from a process box are exchanges which are internal to a process. The exchanges which originate or flow into the sequence line are external exchanges which are shared between high level processes. For example, Figure 3-2, shows information exchanges originating from the 'Perform 3D Coordination' process box for the Laboratory Project. These exchanges, although internal to the 3D Coordination Process, should be identified in the BIM Overview Map since multiple parties author the exchanged information. This ensures that the exchanges will be detailed using the information exchange definition procedure described in Chapter Four.

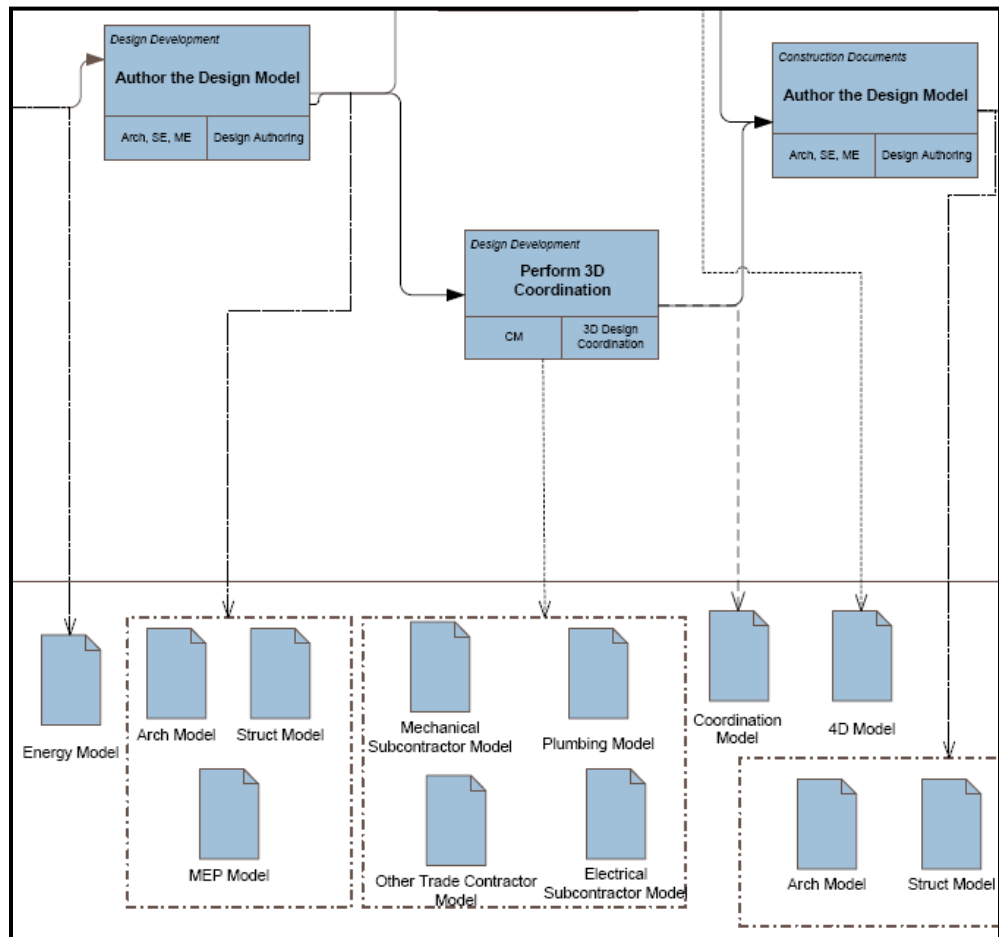

Figure 3-2: Portion of the BIM Overview Map for the Laboratory Project
(see larger formatted version in Appendix E)

To illustrate the results of an overview mapping task, the BIM Overview Map for the Laboratory Project defines the overall BIM Uses that the team has employed for the project which are Design Authoring, Energy Analysis, 4D Modeling, 3D Design Coordination, and Record Modeling (reference Figure 3-3). It identifies that Energy Analysis will be performed during the schematic design phase, where as 4D Modeling and 3D Design Coordination will be performed during design development and the construction document phases. The map also identifies the key Information Exchanges that are shared between different parties.

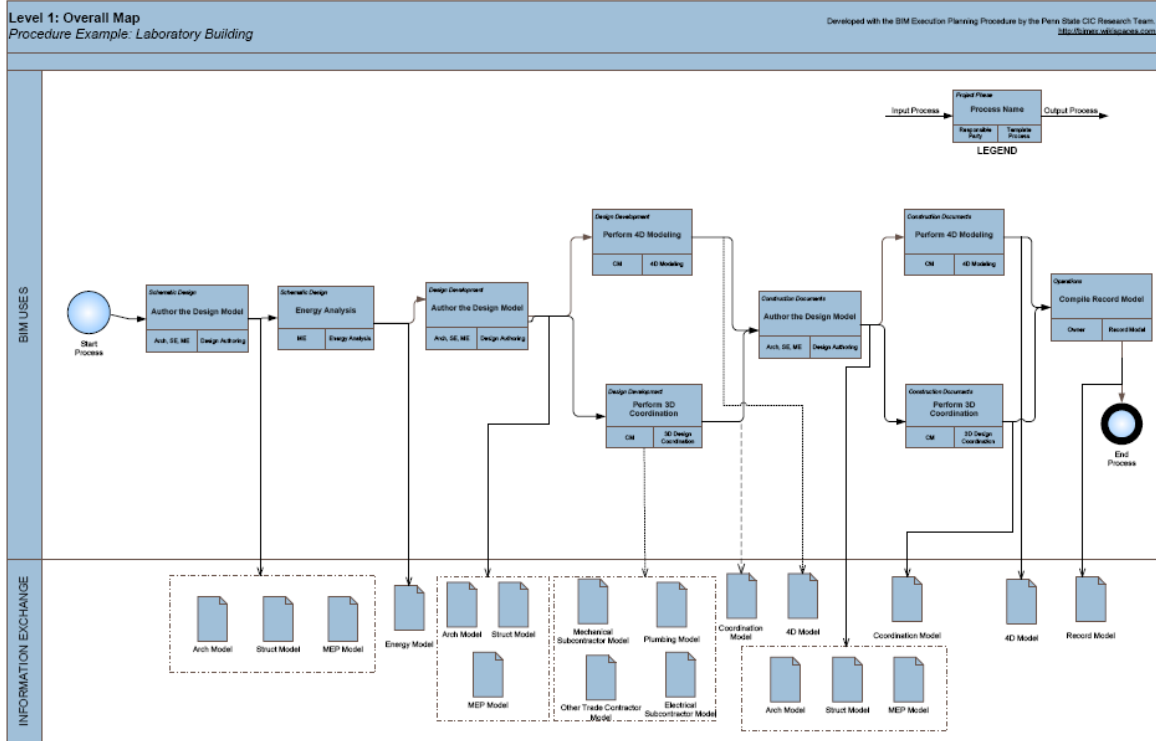

Figure 3-3: BIM Overview Map for the Laboratory Project

3. Creating a Detailed BIM Use Map

After creating an Overview Map, a Detailed BIM Use Process Map must be created for each identified BIM Use to clearly define the sequence of the various processes to be performed within that BIM Use. It is important to realize that each project and company is unique, so there may be many potential methods that a team could use to achieve a particular process. Therefore, these template process maps will need to be customized by project teams to achieve the project and organizational goals. For example, the template process map may need to be tailored to integrate a specific computer application workflow or project team work sequence.

A Detailed BIM Use Process Map includes three categories of information which are represented on the left side of the process map and the elements are included in the horizontal lines (referred to as 'lanes' in the BPMN mapping notation):

1. **Reference Information:** Structured information resources (enterprise and external) required to execute a BIM Use
2. **Process:** A logical sequence of activities that constitute a particular BIM Use
3. **Information Exchange:** The BIM deliverables from one process which may be required as a resource for future processes

To create a Detailed Process Map, a team should:

1) Hierarchically decompose the BIM Use into a set of processes

The core processes of the BIM Use need to be identified. These are represented by a 'rectangular box' symbol within BPMN. These are placed in a sequential order within the Process swim lane.

2) Define the dependency between processes

Next, dependencies between the processes are defined. This is accomplished by defining the connections between processes. The project team needs to identify the predecessor and successor of each process. In some cases it may be possible to have multiple successors and /or predecessors. These processes are then connected using the 'sequence flow' lines in BPMN.

3) Develop the Detailed Process Map with the following information

- a. **Reference Information:** Identify the informational resources needed to accomplish the BIM Use in the 'Reference Information' lane. Examples of reference information include cost databases, weather data, and product data.
- b. **Information Exchanges:** All the exchanges (internal and external) should be defined in the 'Information Exchange' lane. These exchanges are further detailed out in Chapter Four.
- c. **Responsible Party:** Identifies the responsible party for each process. Figure 3-4 displays how to represent this information in the process map.

4) Add Goal Verification Gateways at important decision points in the process

A gateway can be used to ensure that the deliverables or results of a process are met. It could also modify the process path based on a decision. Gateways provide the opportunity for the project team to represent any decisions, iterations or quality control checks required before the completion of a BIM task. Figure 3-4 demonstrates how this can be accomplished within a Detailed BIM Process Map (Level-Two Map).

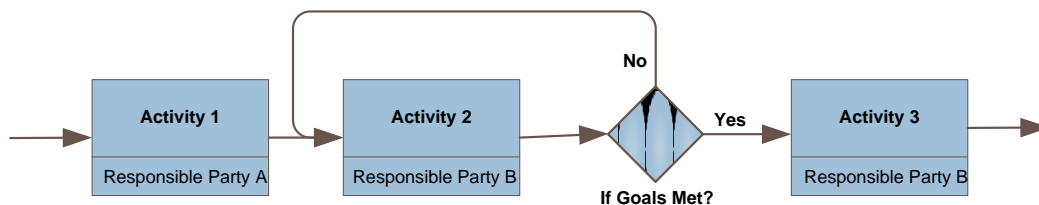

Figure 3-4: Example Goal Verification Gateway

5) Document, review and refine this process for further use

This Detailed Process Map can be further used for other projects by the project team. It should be saved and reviewed at various times throughout the BIM Implementation process. Throughout the project, detailed process maps should be updated periodically to reflect the actual workflows implemented on the project. Additionally, after the project is completed, it may be helpful to review the process maps to compare the actual process used versus the planned process. It is likely that the detailed process maps can be used on future projects. Please reference Figure 3-5 for an example of a Detailed BIM Use Process Map.

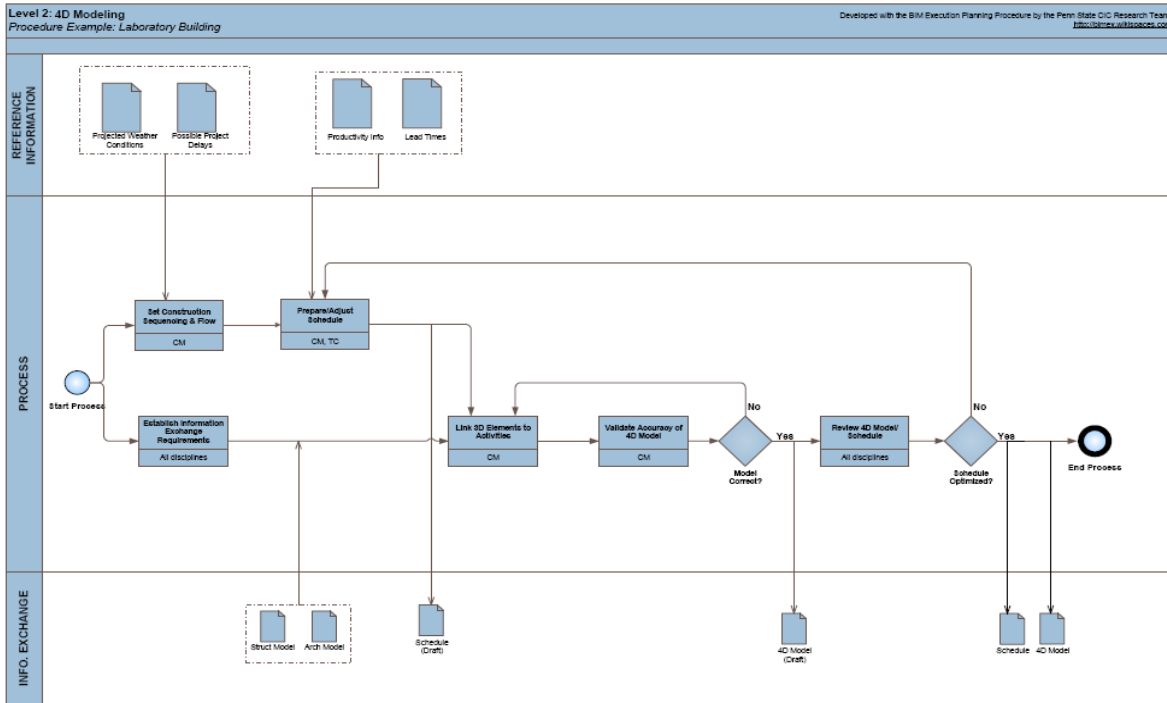

Figure 3-5: Detailed BIM Use Process Map for 4D Modeling for the Laboratory Project (see Appendix E for larger scale map)







4. Symbols Used for Process Map Representation

3

For BIM Execution, the preferred notation for process mapping development is the Business Process Modeling Notation (BPMN) developed by the Object Management Group¹⁰. One of the key elements of the BPMN is the visual appearance of the process map in terms of the symbols and markers used. These should conform to the shapes defined in BPMN specification.

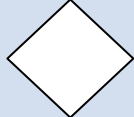
To develop a Process Map for the BIM Plan, the following symbols may be used¹¹:

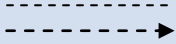
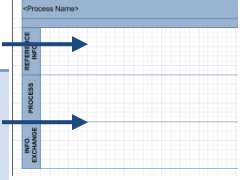
Table 3-1: Process Mapping Notation for BIM Process Maps

Element	Description	Notation
Event	An Event is an occurrence in the course of a business process. Three types of Events exist, based on when they affect the flow: Start, Intermediate, and End.	
Process	A Process is represented by a rectangle and is a generic term for work or activity that entity performs.	
Gateway	A Gateway is used to control the divergence and convergence of Sequence Flow. A Gateway can also be seen as equivalent to a decision in conventional flowcharting.	
Sequence Flow	A Sequence Flow is used to show the order (predecessors and successors) that activities will be performed in a Process.	
Association	An Association is used to tie information and processes with Data Objects. An arrowhead on the Association indicates a direction of flow, when appropriate.	
Pool	A Pool acts as a graphical container for partitioning a set of activities from other Pools.	
Lane	A Lane is a sub-partition within a Pool and will extend the entire length of the Pool - either vertically or horizontally. Lanes are used to organize and categorize activities.	
Data Object	A Data Object is a mechanism to show how data is required or produced by activities. They are connected to the activities through Associations.	 Name
Group	A group represents a category of information. This type of grouping does not affect the Sequence Flow of the activities within the group. The category name appears on the diagram as the group label. Groups can be used for documentation or analysis purposes.	

¹⁰ For more information, please refer to <http://www.omg.org/>

¹¹ For more information, please refer to <http://www.bpmn.org/>

The goal of this chapter is to present a method for defining information exchanges (identified in Chapter Three) between project processes that are crucial to successful BIM implementation. To define these exchanges, the team needs to understand what information is necessary to deliver each BIM Use. To assist in this task, an Information Exchange (IE) Worksheet was designed. The Information Exchange Worksheet should be completed in the early stages of a project after designing and mapping the BIM process. A blank IE Worksheet is available in Appendix F and the procedure for filling out the worksheet is described in Section Two of this chapter.

1. Pulling the Information Through the Project

Every element of a project does not need to be included for a model to be valuable. Therefore, it is important to only define the model components that are necessary to implement each BIM Use. Figure 4-1 depicts an example of how information flows through a BIM implementation process.

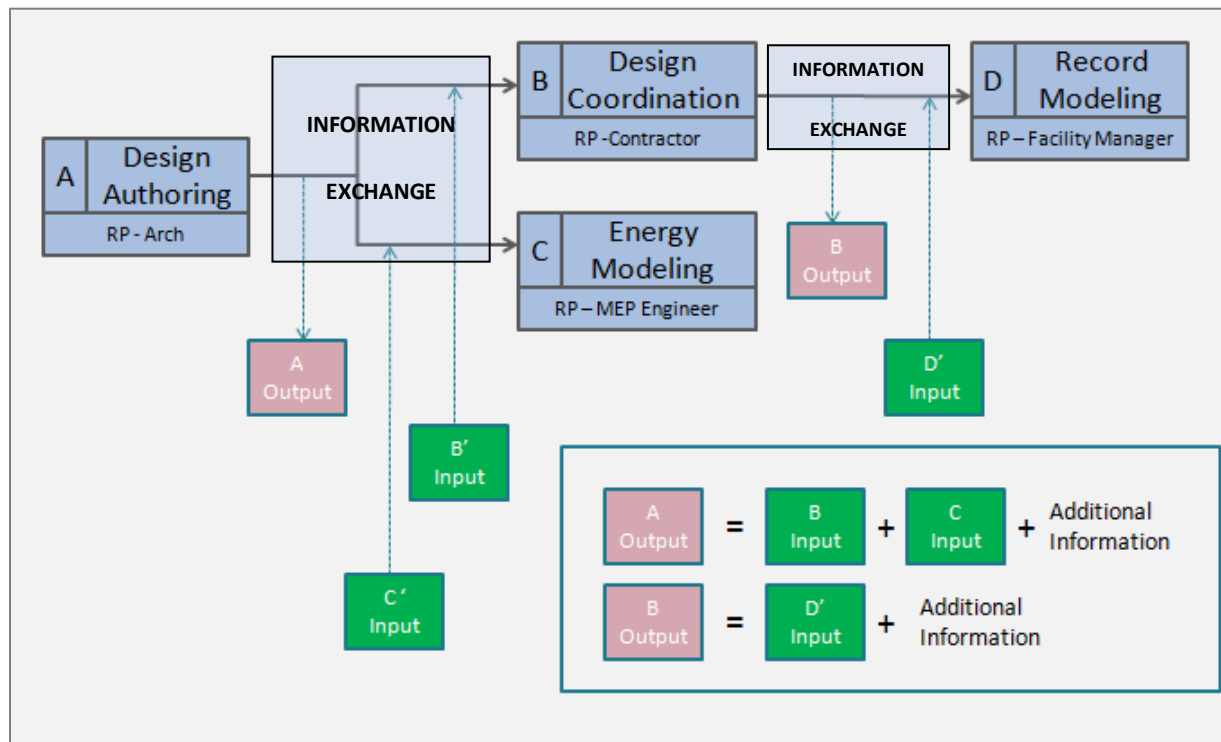

Figure 4-1: Pulling the Information through the Project

This figure was derived from the Level One process map described in Chapter Three. Note that downstream BIM Uses are directly affected by what is produced by the upstream Use. Looking at this example from the perspective of a pull-driven approach, if the model information required to implement a particular BIM Use is not authored by an upstream team member, then the information

2. Information Exchange Worksheet

After process map development, information exchanges between project participants are clearly identified. It is important for the team members and, in particular, the author and receiver of each information exchange transaction to clearly understand the information content. The procedure for creating the information exchange requirements is detailed below:

1) *Identify each potential information exchange from the Level 1 Process Map*

Information Exchanges that are shared between two parties should be defined. One BIM Use may have multiple exchanges; however, to simplify the process, only one exchange is necessary to document each Use. Also, the time of exchange should be derived from the Level One Map. This ensures that the involved parties know when the BIM deliverables are expected to be completed along the project's schedule. The project phases should also be identified in the project specific contract language (Chapter Five). When possible, the BIM Use exchanges should be listed in chronological order to give a visual representation of the progression of the model requirement.

2) *Choose a Model Element Breakdown structure for the project*

After the project team has established the Information Exchanges (IE), the team should select an element breakdown structure for the project. Currently, the IE Worksheet uses the CSI Uniformat II structure; however other options are available on the BIM Execution project website.

3) *Identify the Information Requirements for each Exchange (Output & Input)*

To define each information exchange, the following information should be documented:

- a. **Model Receiver** – Identify all project team members that will be receiving the information to perform a future BIM Use. These parties are responsible for filling out the Input Exchanges. Output exchanges will not have a model receiver, and should be filled out by the project team, initiated by the Architect.
- b. **Model File Type** – List the specific software application(s), as well as, the version that will be used to manipulate the model during each BIM Use by the receiver. This is pertinent in order to identify any interoperability that may exist between exchanges.
- c. **Information** – Identify only the information necessary for the BIM Use implementation. Currently, the IE Worksheet uses a three tier level of detail structure, shown in Table 4-1.

Table 4-1: Information Level of Detail

Information	
A	Accurate Size & Location, include materials and object parameters
B	General Size & Location, include parameter data
C	Schematic Size & Location

- d. **Notes** – Not all necessary requirements for model content may be covered by the information and element breakdown structure, and if more description is needed, it should be added as a note. Notes can be specific to certain modeling content and/or depict a modeling technique.

4) Assign Responsible Parties to Author the Information Required

Each line item in an Information Exchange should have a party who is responsible for authoring the information. The responsibility for creating the information should lie with the party that can produce with the highest level of efficiency. Additionally, the time of input should be when it is needed by the model receiver, based on the level 1 process map. The worksheet can be sorted according to responsible party to determine ones scope for each BIM deliverable. Table 4-2 below is a list of potential responsible parties.

Table 4-2: List of Potential Responsible Parties

Responsible Party	
ARCH	Architect
CON	Contractor
CE	Civil Engineer
FM	Facility Manager
MEP	MEP Engineer
SE	Structural Engineer
TC	Trade Contractors

5) Compare Input versus Output Content

Once the information requirements are defined, it is necessary for the project team to discuss the specific elements where the Output information (Authored) does not match the Input information (requested). The example in Figure 4-2 depicts an inconsistency between a Design Authoring Output Model and an Energy Analysis Input Model. When this occurs, two potential remedial actions need to take place:

1. Output Information Exchange Requirement –revise the information to a higher level of accuracy and/or include additional information (e.g. add R-Value to Exterior Walls); OR
2. Input Information Exchange Requirement –revise the responsible party so that information is authored by the organization performing the BIM Use.

Information		Responsible Party	
A	Accurate Size & Location, include materials and object parameters	ARCH	Architect
		CON	Contractor
		CE	Civil Engineer
B	General Size & Location, include parameter data	FM	Facility Manager
		MEP	MEP Engineer
C	Schematic Size & Location	SE	Structural Engineer
		TC	Trade Contractors

A Output = B' Input + C' Input + Additional Information

Information Exchange Title		Design Authoring OUTPUT			3D Coordination INPUT			Energy Analysis INPUT			
Time of Exchange (SD, DD, CD, Construction)					DD			DD			
Model Receiver		N/A			C, TC			MEP			
Receiver File Format											
Application & Version											
Model Element Breakdown		Info	Resp Party	Notes	Info	Resp Party	Notes	Info	Resp Party	Notes	
B	SHELL										
	Superstructure										
		Floor Construction	B	A		B	A		B	A	
		Roof Construction	B	A		B	A		B	A	
	Exterior Enclosure										
		Exterior Walls	B	A		A	A		B	A	R Value
		Exterior Windows	B	A		B	A		A	A	Rvalue
		Exterior Doors	B	A					C	A	
	Roofing										
		Roof Coverings	B	A							
	Roof Openings	B	A		A	A		B	A		
C	INTERIORS										
	Interior Construction										
		Partitions	B	A		B	A		B	A	
		Interior Doors							C	A	
		Fittings	B	A		B	A			A	
	Stairs										
		Stair Construction	B	A		B	A		B	A	
		Stair Finishes									
	Interior Finishes										
		Wall Finishes							B	A	Reflectance
	Floor Finishes							B	A	Reflectance	
	Ceiling Finishes							B	A	Reflectance	
D	SERVICES										

Figure 4-2: Information Exchange Worksheet Example

- = Output Inadequacy (Revise Information) OR
- = Input Inadequacy (Revise Responsible Party)

The final step in the four-part BIM Project Execution Planning Procedure is to identify and define the project infrastructure required to effectively implement BIM as planned. Fourteen specific categories support the BIM project execution process. These categories, as displayed in Figure 5-1, were developed after analyzing the documents listed below¹², reviewing current execution plans, discussing the issues with industry experts and revised through extensive review by various industry organizations.



Figure 5-1: BIM Project Execution Plan Categories

This chapter describes each category of the BIM Project Execution Plan. Information for each category can vary significantly by project, therefore the goal of the description is to initiate discussion and address content areas and decisions which need to be made by the project team. Additionally a template BIM Project Execution Plan has been developed and is available on the project website¹³ and referenced in Appendix G – BIM Project Execution Plan Template. Please note that the information contained in the template will have to be customized based on the project. Additional information may be necessary, while other information could be removed.

¹² The AIA BIM Protocol Exhibit, the ConsensusDOCS BIM Addendum, the United States Army Corps of Engineers (USACE) BIM Roadmap and the Autodesk Communication Specifications define processes, standards and/or contract language for BIM execution on projects. The contents of these documents were compiled and organized to determine key aspects of BIM implementation both on a project and within an organization. The content categories of these implementation documents are contained in Appendix G of this document, along with their relation to the BIM Project Execution Planning categories defined in this guide.

¹³ www.engr.psu.edu/BIM

1. BIM Project Execution Plan Overview

It is important for the project team to understand the reason that a BIM Project Execution Plan was created. This section should include information such as a BIM mission statement and other executive summary level information. This section should be used to establish the importance of the plan.

2. Project Information

5

When developing the Project Execution Plan, the team should review and document critical project information that may be valuable for the BIM team for future reference. This section includes basic Project information that may be valuable for current and future. It can be used to help introduce new members to the project as well as help others reviewing the plan understand the project. This section may include items such as project owner, project name, project location and address, contract type / delivery method, brief project description, project number(s) and the project schedule / phases / milestones. See figure 5-2 for example project information items. Any additional general project information can and should be included in this section. Additional project information includes unique project characteristics, project budget, project requirements, contract status, funding status, and unique project requirements, etc.

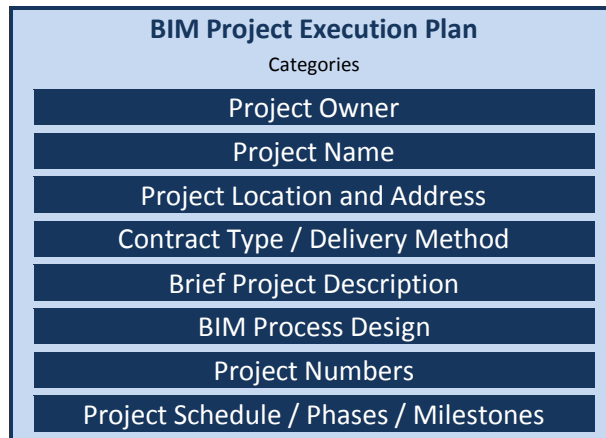

Figure 5-2: Diagram of Critical Project Overview Information

3. Key Project Contacts

At least one representative from each stakeholder involved should be identified including the owner, designers, consultants, prime contractors, subcontractors, manufacturers, and suppliers. These representatives could include personnel such as Project Managers, BIM Managers, Discipline Leads, Superintendents and other major project roles. All stakeholders' contact information should be collected, exchanged, and when convenient, posted on a shared collaborative project management web-portal.

4. Project BIM Goals / BIM Uses

The BIM Project Execution Plan should document the previous steps in the BIM project execution planning process. It is valuable for the team to document the underlying purpose for implementing BIM on the project as well as explain why key BIM Use decisions were made. The plan should include a clear list of the BIM goals, the BIM Use Analysis Worksheet, as well as specific information on the BIM Uses selected. The procedure to identify appropriate BIM Uses for a project is outlined in detail in Chapter 2: Identifying BIM Goals and BIM Uses.

5. Organizational Roles and Staffing

The roles in each organization and their specific responsibilities must be defined. For each BIM Use selected, the team must identify which organization(s) will staff and perform that use. This includes the number of personnel by job title necessary to complete the BIM Use, the estimated worker hours, the primary location that will complete the Use and the Lead organizational contact for that Use. Depending on which phase of a project's lifecycle this plan is completed several items in this section may be challenging to complete. Like the rest of the Plan, as much as possible should be completed and the remaining should be completed as the information becomes available.

6. BIM Process Design

The process maps created for each selected BIM Use in step two of the BIM Project Execution Planning Process should be documented in the Plan. These process maps provide a detailed plan for implementation of each BIM Use. They also define the specific information exchanges for each activity, building the foundation for the entire execution plan. The plan should include the overview map of the BIM Uses, a detailed map of each BIM Use, and a description of elements on each map. For further explanation of the steps to create process maps, please refer to Chapter 3: Designing the BIM Project Execution Process.

7. BIM Information Exchanges

The team should document the information exchanges created as part of the planning process in the BIM Project Execution Plan. The information exchanges will illustrate the model elements by discipline, level of detail, and any specific attributes important to the project. The project models do not need to include every element of the project, but it is important for the team to define the model components and discipline specific deliverables to maximize value and limit unnecessary modeling on the project. For further explanation of the steps to create information exchanges, please refer to Chapter 4: Developing Information Exchanges.

8. BIM and Facility Data Requirements

Some project owners have very specific BIM requirements. It is important for the plan to document the BIM requirements in the native format from the owner. This way the team is aware of the requirements and can plan accordingly to deliver those requirements.

9. Collaboration Procedures

5

The team must develop their electronic and activity collaboration procedures. This includes model management (e.g., model check-out, revision procedures, etc.), and standard meeting actions and agendas.

Collaboration Strategy

The team should document how the project team will collaborate in general. When planning, consider items such as communication methods, document management and transfer, and record storage, etc.

Collaboration Activity Procedures

Specific collaboration activities should be defined, which may include:

1. Identify all collaborative activities that support or are supported by BIM
2. Determine which project stage or phase that activity will take place
3. Determine the appropriate frequency for that activity
4. Determine the participants necessary to conduct that activity properly
5. Determine the location for that activity to take place

Model Delivery Schedule of Information Exchange for Submission and Approval

Determine the schedule for information exchange between parties. Information exchanges should be analyzed in earlier steps; however it is helpful to document them all in one place. Information that should be considered includes:

1. Information Exchange Name (should be drawn from step 3 of the planning process)
2. Information Exchange Sender
3. Information Exchange Receiver
4. One-Time or Frequency (is this a one – time or periodic exchange? If periodic, how often?)
5. Start and due dates
6. Model file Type
7. Software used to create file
8. Native file type
9. File exchange types (receiver file type)

Interactive Workspace

The project team should consider the physical environment it will need throughout the lifecycle of the project to accommodate the necessary collaboration, communication, and reviews that will improve the BIM Plan decision making process. Describe how the project team will be located. Consider questions like “will the team be collocated?” If so, where is the location and what will be in that space? Will there be a BIM Trailer? If yes, where will it be located and what will be in the space such as computers, projectors, tables, table configuration? Include any necessary information about workspaces on the project.

Electronic Communication Procedures

Establish communication protocol with all project team members. Electronic communication with stakeholders can be created, uploaded, sent out and archived through a collaborative project management system. Save copies of all project related communication for safekeeping and future reference. Document management (file folder structure, permissions and access, folder maintenance, folder notifications, and file naming convention) should also be resolved and defined.

10. Quality Control

Project teams should determine and document their overall strategy for quality control of the model. To ensure model quality in every project phase and before information exchanges, procedures must be defined and implemented. Each BIM created during lifecycle of the project must be pre-planned considering model content, level of detail, format and party responsible for updates; and distribution of the model and data to various parties. Each party contributing to the BIM model should have a responsible person to coordinate the model. This person, as part of the BIM team, should participate in all major BIM activities as required by the team. They should be responsible for addressing issues that might arise with keeping the model and data updated, accurate, and comprehensive.

Quality control of deliverables must to be accomplished at each major BIM activity such as design reviews, coordination meetings or milestones. The standard of data quality should be established in the planning process and agreed upon by the team. Standards such as AEC CADD and National Building Information Model Standards may be appropriate for the team to consider. If a deliverable does not meet the team’s standards, the reason why the deliverable is lacking should be further investigated and prevented in the future. The deliverable needs to comply with standards required by the owner and agreed upon by the project team.

Quality Control Checks

Each project team member should be responsible for performing quality control checks of their design, dataset and model properties before submitting their deliverables. Documentation confirming that a quality check was performed can be part of each submittal or BIM report. The BIM Manager should be the one to confirm quality of the model after the revisions were made. The following quality control checks should be considered when determining a plan for quality control:

- **Visual Check:** Ensure there are no unintended model components and the design intent has been followed by using navigation software
- **Interference Check:** Detect problems in the model where two building components are clashing by a Conflict Detection software
- **Standards Check:** Ensure that the model is to the standards agreed upon by the team.
- **Element Validation:** Ensure that the dataset has no undefined or incorrectly defined elements

Each party should designate a responsible party to make sure that the agreed upon process for quality control of models and data has been followed before accepting submittals and model revisions.

11. Technology Infrastructure Needs

The team should determine the requirements for hardware, software platforms, software licenses, networks, and modeling content for the project.

Software

Teams and organizations need to determine which software platforms and version of that software is necessary to perform the BIM Uses that were selected during the planning process. It is important to agree upon a software platform early in the project to help remedy possible interoperability issues. File formats for information transfer should have already been agreed upon during the information exchange planning step. Additionally, the team should agree upon a process for changing or upgrading software platforms and versions, so that a party does not create an issue where a model is no longer interoperable with other parties.

Computers / Hardware

Understanding hardware specifications becomes valuable once information begins to be shared between several disciplines or organizations. It also becomes valuable to ensure that the downstream hardware is not less powerful than the hardware used to create the information. In order to ensure that this does not happen, choose the hardware that is in the highest demand and most appropriate for the majority of BIM Uses.

Modeling Content and Reference Information

The project and reference information, such as Modeling families, workspaces, and databases, must be considered to ensure that the project parties will use consistent standards.

12. Model Structure

The team must identify the methods to ensure model accuracy and comprehensiveness. After agreeing on collaboration procedures and technology infrastructure needs, the planning team should reach consensus on how the model is created, organized, communicated and controlled. Items to consider include:

- Defining a file naming structure for all designers, contractor, subcontractors, and other project members
- Describing and diagram how the models will be separated (e.g. by building, by floors, by zones, by areas, and/or by disciplines)
- Describing the measurement system (imperial or metric) and coordinate system (geo-referenced / origin point) to be used to allow for easier model integration.
- Identifying and agreeing upon items such as the BIM and CAD standards, content reference information, and the version of IFC, etc.

13. Project Deliverables

The project team should consider what deliverables are required by the project owner. With the deliverable project phase, due date format and any other specific information about the deliverable should be considered.

14. Delivery Strategy / Contract

When implementing BIM on a project, attention should be paid to the delivery method and contraction methods before the project begins. Ideally a more integrated approach such as design-build or Integrated Project Delivery (IPD) would be used. While it usually yields the best results for the project, an integrated approach is not always possible on all projects. This could be because of a number of reasons. Additionally the contract type and delivery method may have already been selected before BIM planning takes place. If this is the case the team needs to consider future subcontractors and consultants and also consider what steps are necessary to ensure successful BIM implementation no matter what the delivery method. BIM can be implemented successfully within all delivery methods.

Definition of Project Delivery Approach

If the project contract type or delivery method have not yet been determine, it is important to consider how they will affect the implementation of BIM on the project. All delivery methods can benefit from the use of BIM; however core concepts are more easily implemented with higher levels of integration in the project delivery process. When planning the impact of BIM on the delivery approach, the planning team should consider the four main decisions:

- Organizational Structure and Typical Delivery Method
- Procurement Method
- Payment Method
- Work Breakdown Structure

Consider BIM requirements when selecting the delivery approach and when drafting contracts. Integrated Project Delivery (IPD) and Design-Build are highly collaborative delivery methods that

facilitate information sharing based on the risk and reward structure¹⁴, and several new contract forms were recently released to address BIM, delivery structure and contracting¹⁵.

If you do not plan to use IPD or Design-Build on a project or the delivery method has already been selected, BIM can still successfully be implemented with other delivery structures, such as Design-Bid-Build or CM at Risk. When using a less integrated delivery structure, it is important to work through an initial BIM Execution Process and then assign roles and responsibilities in the contract structure. It is also important that there is buy-in from all the team members so that all parts can have as much success as possible. Without buy-in from all members, it will decrease the quality of the BIM product, lead to added work by other project members and could result, at worst, in unsuccessful implementation of BIM on that project.

Team Selection Procedure

The planning team needs to consider the criteria and procedure for the selection of future project team members based on their organization's BIM ability. When creating the criteria, the team needs to review the competencies for each BIM Use selected during the planning process. After the required competencies are determined, project teams should require the new project members to display that they have those competencies through examples of prior work or demonstrations. It is critical that all team members have the ability to perform their BIM responsibilities.

BIM Contractual Language

Integrating BIM on a project not only improves particular processes, but also increases the degree of project collaboration. Collaboration is of particular importance when the contract affects the degree of change in the project delivery process and provides some control over potential liability issues¹⁶. The owner and team members should pay careful attention to the drafting of BIM contractual requirements since they will guide the participant's actions.

14 Please refer to the following documents for more information on IPD and Design-Build: AIA IPD Agreements: C196-2008, C197-2008; AIA Integrated Project Delivery Guide (IPDG); AIA Design Build (DB) Agreements: A441-2008, C441-2008. DBIA, ConsensusDOCS, and EJDC documents also include information beyond the scope of this project.

15 More information and samples of the AIA and ConsensusDOCS documents can be found at www.aiacontractdocuments.org and www.consensusdocs.org.

16 Larson, D.A., and K.A. Golden (2008). "Entering the Brave New World: An Introduction to Contracting for BIM." William Mitchell Law Review, Volume 34.

The following areas should be considered and included in contracts where applicable:

- Model development and responsibilities of parties involved (Chapter Four)
- Model sharing and Model reliability
- Interoperability / file format
- Model management
- Intellectual property rights
- Requirement for BIM Project Execution Planning

Standard contracts may be used on BIM projects, but edit the contents to include the necessary items mentioned. There are several contract addendums or modified contract forms that address BIM implementation on a project (see below¹⁷). A written BIM Project Execution Plan should be specifically referenced and required within the developed contracts for the project so that team members participate in the planning and implementation process.

BIM requirements should also be incorporated into consultant, subcontractor and vendor agreements. For example, the team may require each subcontractor to model the scope of work for 3D design coordination, or they may wish to receive models and data from the vendors for incorporation into the coordination or record models. Modeling initiatives required by consultants, subcontractors, and vendors must be clearly defined within the contracts including the scope, schedule for delivery of the model, and file / data formats. By having the BIM requirements in the contract, team members are legally required to complete implementation as planned. If BIM was not written into contracts, additional steps are required to ensure that the BIM Plan is followed by all project participants.

¹⁷ Several contract addendums or modified contract forms address BIM implementation on a project: AIA E202-2008: BIM Protocol Exhibit. This document addresses the development of a model throughout a project; AIA E201-2007 Document: Digital Data Protocol Exhibit; ConsensusDOCS 301 BIM Addendum. This document addresses the risk management of a BIM design process; AIA C196-2008, C197-2008: IPD Agreements.

The development of the BIM Plan is a collaborative process. Some portions of the procedure, e.g., discussing the overall project goals, are collaborative tasks, while other portions, e.g., defining the required file structure or a detailed information exchange, do not necessarily require collaboration. The key to successfully developing the plan is to ensure that meetings are scheduled for the collaborative tasks when needed, and that the non-collaborative tasks are completed in a timely manner, in preparation for these meetings. The BIM Plan can be developed through a series of collaborative meetings, followed by work tasks which take place between the meetings. A series of four meetings have been defined to develop the BIM Plan. The goal of presenting this four meeting series is to illustrate one structure that the team can use to effectively develop the plan. For some projects, the team may be able to reduce the number of meetings through effective collaboration between meetings.

1. Meeting Structure for Developing a BIM Project Execution Plan

The four meetings proposed to develop the BIM Project Execution Plan are closely aligned with the primary steps outlined in Chapter One. The meetings and interim tasks include:

Meeting 1: Identify BIM Goals and Uses

The first meeting should focus on the discussion of the overall goals for implementing BIM, along with identifying the BIM Uses. A draft agenda for this meeting would include:

1. Introduce and Discuss BIM Experiences (both individual and organizational)
2. Develop BIM goals (reference BIM Goal template document)
3. Identify which BIM Uses to pursue (reference the BIM Uses worksheet)
4. Develop the frequency and sequencing for the BIM Uses and identify a responsible party to develop the high level (Level One) BIM Overview process map
5. Identify the responsible parties to develop detailed BIM Use process maps, e.g., the level two maps
6. Organize the schedule for future meetings
7. Agree on the tasks ahead and who is responsible for each

This meeting should be attended by senior management personnel and BIM management staff for all involved participants including the owner, designers, contractors and key subcontractors.

Tasks Prior to Meeting 2

After the initial kick-off meeting, the organizations should clearly understand who will be responsible for the defined tasks, and in what sequences the BIM Uses will be executed. The responsible party for the Level One map should clearly document and distribute it to the project team for review prior to the following meeting. Each responsible party for the specified BIM Uses should also draft their workflow prior to the Design BIM Project Execution Process meeting (Meeting 2).

Meeting 2: Design BIM Project Execution Process

The Project Specific BIM Use Process Maps shall contain a detailed process plan that clearly defines the different activities to be performed, who will perform them, and what information will be created and shared with future processes. The agenda for this meeting will include:

1. Review the initial BIM Goals and Uses
2. Review the high level BIM Overview Process Map
3. Review the more detailed workflows from the various parties and identify areas of overlap or gaps between the various modeling tasks
4. Review the process to address opportunities and concerns
5. Identify the primary information exchanges within the process
6. Identify responsible parties for coordinating each information exchange including the author and user of each exchange
7. Allow sub-teams for each information exchange to coordinate potential interim meetings as needed to discuss the information exchange requirements
8. Agree on the tasks ahead and who is responsible for each

This meeting should be attended by the owner, BIM managers and project manager for the project. It may also be valuable to have contracting managers in attendance or have them briefed soon after this meeting.

Tasks Prior to Meeting 3

After the Design BIM Project Execution Process meeting, the team must focus on developing the information exchanges. Each responsible party for an exchange should take the lead in developing the information exchanges. The authors of the information exchange will need to coordinate with the information receivers to ensure that they have developed consistent information exchanges with minimal inconsistencies to discuss at Meeting Three.

The team members should also prepare for the discussions regarding infrastructure requirements which will occur in Meeting Three. Team members should compile examples of typical methods that they have used or wish to use on the project to share with the team.

Meeting 3: Develop Information Exchanges and Define Supporting Infrastructure for BIM Implementation

The agenda for this meeting will include:

1. Review the initial BIM Goals and BIM Uses to ensure that the project planning remains consistent with the initial goals
2. Review the information exchange requirements developed by the team members between Meeting Two and Meeting Three
3. Identify the infrastructure needed to support the process and information exchanges as defined in Chapter Five
4. Agree on tasks ahead and who is responsible for each

This meeting should be attended by the BIM managers. It may also be valuable to have contracting managers in attendance or briefed soon after this meeting.

6

Tasks Prior to Meeting 4

The categories and information should be compiled into the final BIM Execution Plan format and distributed to the project team in preparation for the final plan review meeting.

Meeting 4: Review Final BIM Project Execution Plan

The agenda for this meeting will include:

1. Review the draft BIM Project Execution Plan
2. Develop the project controls system to ensure that the plan is being followed, and that the plan is up to date
3. Outline the procedure for formal adoption of the BIM Project Execution Plan and monitoring process
4. Agree on tasks ahead and who is responsible for each

This meeting should be attended by the owner, BIM managers, and all parties that are responsible for the identified BIM Uses.

Tasks after Meeting 4

Once the meetings are complete, the BIM Project Execution Plan should be distributed to all parties and approved as appropriate for the project and contracting structure. Team members should ensure that the plan monitoring and updating procedure is implemented into the project controls system.

2. Planning Meeting Schedule

One of the first tasks of the team is to determine the planning meeting schedule. This schedule should identify the defined meetings, along with the scheduled dates for the meeting. The team may decide that they wish to spread the planning procedure across several weeks with one of the defined meetings each week or every other week. But they also may wish to define an accelerated planning schedule over several days with the team specifically focused on the development of the plan.

3. Monitoring Progress against the BIM Execution Plan

6

Once the initial BIM Execution Plan is created, it will need to be continuously communicated, monitored and updated throughout the project. In particular, the Project Execution Plan should be embedded into appropriate contracts, and then updated as needed when new team members join the project team. At a minimum, it is valuable for the BIM managers from the various team members to meet on a monthly basis to discuss the progress of the information modeling initiatives on the project and to address any implementation challenges that team members may be encountering. These meetings may be incorporated with other team meetings, but it is important to specifically address issues that may arise in the implementation of the plan. It is important for the team to continuously modify the planned process as needed due to the addition of team members, revisions to available technology, changes to the overall project conditions, and to reflect the actual process that evolved. The team should agree to a formal plan for accepting updates to the plan, and then accurately document any changes to the original plan for communication to other team members, as well as for accurate future use and reference.

As stated in the introduction, BIM Plans require typical methods developed by each organization involved. The purpose of this chapter is to define how organizations can use the BIM Project Execution Planning procedure to develop these typical methods for BIM project implementation. Figure 7.1 revisits the BIM planning concept to show how organizational means and methods play a vital role in the implementation process. To obtain the greatest benefit from BIM, the organizations must be willing to develop and share this information with the project team.

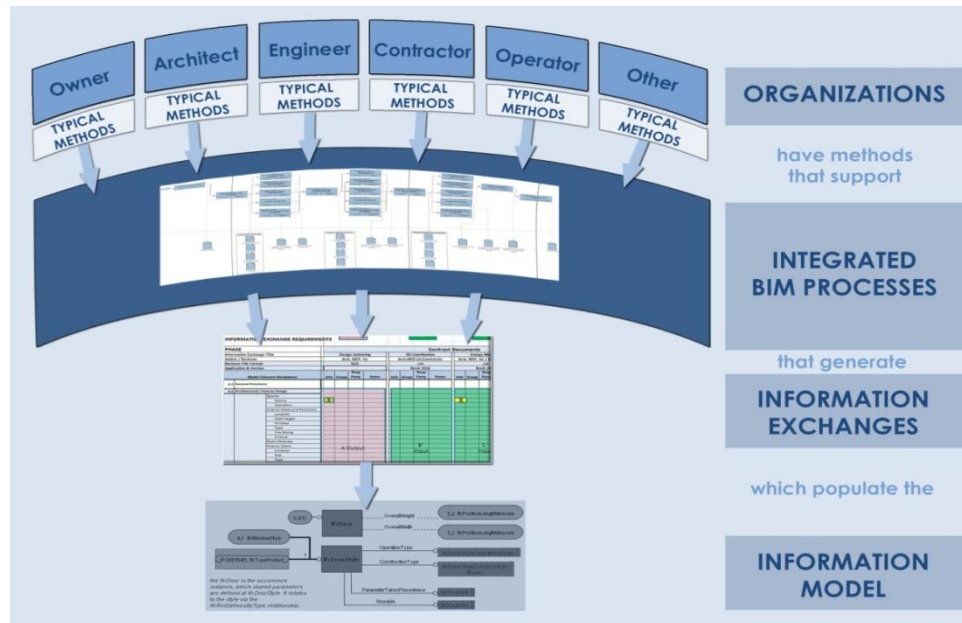

Figure 7-1: The BIM Project Execution Planning Concept

Organizations should develop internal standards defining how they intend to use BIM as on an organizational level. By completing the planning process as an organization prior to the BIM Plan for an individual project, each stakeholder will have a starting point for planning and be able to modify existing organizational standards rather than creating entirely new processes. Additionally, these standards can be shared within the organization to help communicate typical means and methods. Using a similar four-step procedure with minor modifications, organizations can create BIM Project Execution Planning standards to be used on future projects.

1. BIM Mission Statement and Goals

The organization should establish a BIM mission statement. When creating the mission statement, consider why BIM is important to the organization and the reasons for using BIM such as gaining a competitive advantage on proposals, increasing productivity, improving design quality, reacting to industry demand, satisfying owner requirements, or improving innovation. Developing a clear mission statement sets the stage for future organizational decisions related to BIM.

After a mission statement is established, the planning team should develop a list of standard project goals that would be beneficial to the organization and typical projects. The list can be divided into several categories such as required, recommended, and optional for each project type. The goals created should be modifiable based on individual project and team characteristics. Defining standard goals will allow each project team to select from a “menu” of potential goals which will ensure a more comprehensive list of goals along with reduce the time to develop the goals.

7

2. BIM Uses

An organization should define typical BIM Uses for future projects that align with the goals established within the organization. Some Uses should be required for every project, while others can only be suggested or optional based on team and project characteristics. Standard BIM Uses can be determined using the tools for project execution planning such as the BIM Use Analysis Worksheet. Using this worksheet, the planning teams can assess the current BIM competencies which the organization possesses and the additional competencies required for each use. When determining which BIM Uses should be required or suggested, it is important to recognize which BIM Uses build upon each other. If an organization controls multiple processes in a value stream, there will be potential benefits in implementing uses across the multiple processes. It is also critical that the planning team is not overambitious about which BIM Uses are required and ensure that the selected BIM Uses are realistic for project teams to accomplish. By determining which BIM Uses will be selected for each project, it will increase the chance of those uses being completed and will also allow the organization to properly evaluate which uses are most beneficial.

3. BIM Process Maps

Standard BIM Process Maps should be created to demonstrate the organization’s BIM process(es) to project team members internally and externally. While the creation of a generic Overview (Level One) Process Map may be beneficial to the project team, this will vary greatly from project to project (depending on which Uses are selected). Therefore, it is more valuable for organizations to devote time to the Detailed (Level Two) Process Maps. Multiple process maps may be required for each BIM Use depending upon the software, level of detail, contract type, delivery method, and project type. Additionally, it may be helpful to create instructions and specifications for each process map generated. Each project team will then take the level two process maps and customize them based on the project’s and team’s needs.

4. BIM Information Exchanges

The organizational planning team should establish standard information exchanges for each BIM Use which they perform. The planning team should identify the information needed for each use; the person who is typically responsible for generating this information; and the preferred format for the information exchange. It may also be necessary to create multiple information exchanges for each use based on different conditions such as software platform, level of detail, and project complexity. A typical model element breakdown should also be selected and standardized across the organization when practical. Understanding the information requirements for each BIM Use will greatly streamline the planning needed for each project and the information exchange step in the Project Execution Planning Procedure will simply focus on finding inconsistency in the data that will be generated by one organization and needed by another.

5. BIM Infrastructure

When planning organizational standards for BIM Project Execution Planning, it is important to consider all the resources and infrastructure required to perform the selected processes. For each BIM Use selected, the planning team should determine the personnel who will perform each use; establish a plan for adapting each BIM Use's personnel based on project size, complexity, level of detail and scope; and determine which personnel will typically oversee the BIM Use.

The organization should design standard collaboration procedures. Included in this task is crafting standard strategies based on different project types and delivery methods. The planning team should also determine standard collaboration activities and meetings that will take place on typical projects including frequency and required attendees. It is also essential that the organization establishes standard electronic communication procedures. Specific items that should be addressed include file storage and backup systems; standard file folder structures; standard file naming conventions; standard content libraries; and standards for sharing of information both externally and internally.

Along with collaboration procedures, information management quality assurance and control is valuable for every project. The quality of a model can significantly impact a project; therefore the organization should have standard quality control processes that are well documented and allow for easy implementation to ensure the level of quality required for each modeling use.

The planning team should assess the software and hardware needs of each BIM Use and compare the technical infrastructure needs to the current software and hardware. Necessary upgrades and purchases should be made to ensure that the software and hardware does not limit the successful modeling performance. If the proper equipment is not in place, it could result in lower productivity and increased time and cost for each BIM Use.

Typical project deliverables need to be established based on different project characteristics. Project Owners should establish a list of deliverables for each project based on all the information generated during the planning process. Designers and contractors should also create a “menu” of BIM services that add value to the overall project.

It is valuable to consider how BIM will be incorporated into both prime contracts and subcontracts. Requirements for BIM, including BIM Project Execution Planning, BIM Uses, and information exchanges, should be written into contracts. The planning team should develop draft language that can be incorporated into contracts, along with developing procedures for team which will allow the organization to identify appropriate team members.

6. Developing the BIM Project Execution Plan

7

By performing organizational level planning, the team can reduce the amount of time spent on each step of the planning process and maintain a manageable planning scope by defining their standard goals, uses, processes, and information exchanges. The BIM Project Execution Planning Procedure requires organizations to provide information regarding their standard practices, including information exchanges. While certain contract structures can lead to collaboration challenges, the goal of this procedure is to have the team develop a BIM process containing deliverables that will be beneficial to all members involved. To reach this goal, the project team needs to have open lines of communication. To be successful, the team members must buy in to the process and be willing to share this intellectual content with other team members.

This guide outlines a structured, four step BIM Project Execution Planning Procedure, along with appropriate implementation guidelines. The implementation of this procedure has been performed on seven projects and within three organizations. By analyzing the successes and challenges encountered within these implementation case studies, the following ten recommendations for successful implementation were identified.

1) Each project team needs a BIM Champion. A project using the BIM Project Execution Planning Procedure is more likely to succeed when there is at least one person with a strong desire to develop the BIM Plan. These champions take time to learn the procedure and work to help compile the final BIM Plan. They also market the value and necessity of the process to the other project team members. It is important that the champion(s) on a project encourages the team to take the time to plan the work, even if there is strong schedule pressure to begin developing model content prior to the completion of the planning process. The BIM champion could be from any primary organization, or even a third party, but within the case study projects, these champions were primarily from the owner or construction manager organization.

2) Owner involvement is critical throughout the entire process. By providing the guidelines for model and information deliverables, the owner can emphasize the importance of BIM implementation for reaching their desired end goals for the facility. Owner involvement and enthusiasm regarding the process can encourage project team members to seek the best processes that will benefit the entire project. Owners should consider writing a BIM Project Execution Plan into their contract documents to ensure that the planning process is performed to a level of detail which meets their expectations.

3) It is essential that the project team fosters an open environment of sharing and collaboration. The BIM Project Execution Planning Procedure requires organizations to provide information regarding their standard practices, including information exchange requirements. While certain contract structures can lead to collaboration challenges, the goal of this procedure is to have the team develop a BIM process containing deliverables that will be beneficial to all members involved. To achieve this goal, the project team should have open lines of communication. The team members must buy-in to the process and be willing to share their intellectual content with other team members.

4) The BIM Project Execution Planning Procedure can be adapted to different contracting structures. The BIM process has the ability to be more comprehensively adopted in more integrated project delivery approaches. However, none of the case studies used to validate the procedure were used with a specific Integrated Project Delivery (IPD) contract. The core steps of the procedure are helpful no matter which delivery method is used, but there are added challenges when implementing the planning when all core team members are not involved in the early stages of the project. Depending on the contract strategy, additional steps may be needed to ensure project planning success, and early assumptions may be needed to plan for future team members.

5) There is great value in early planning. If planning does not take place early, extra time may be needed to resolve inconsistencies downstream. This often results in more time and resources used than the original planning would have needed.

6) The BIM Plan should be treated as a living document. When beginning the BIM Project Execution Planning Procedure, it is valuable to understand that the BIM Plan will be need to be flexible and the plan should be reviewed and updated on a periodic basis. It is unrealistic to assume that the project team will have all information necessary to avoid assumptions that may need to be made to develop the BIM Plan at the inception of the project. It will take time to populate the information because additional and new information must be incorporated as project team members are added.

7) Once an initial plan is developed, it must be reviewed regularly. A revision schedule should be set based on a frequency that the project team deems appropriate. Throughout the life of the project, it is important to keep the initial project goals in mind to ensure that the team is working towards their completion. If there is any deviation, reassessment of or rededication to the original goals should occur.

8) The appropriate resources must be made available to ensure planning success. It is important to keep in mind that the level of effort needed for this process should not be underestimated. Project teams must consider the time allocated for planning when generating both the project schedule and project budget. Due to the learning curve associated with this process, teams should overestimate the time it will take to produce a BIM Project Execution Plan. The time associated with the learning curve can be reduced by educating involved team members before delving into the process. Without proper planning before the project specific meetings begin, many unexpected issues may arise that could have been solved at an earlier time.

9) Developing an organizational BIM Project Execution Plan before project inception can decrease project planning time. By performing organizational level planning, the team can reduce the amount of time spent on each step of the planning process and maintain a manageable planning scope by defining their standard goals, uses, processes, and information exchanges.

10) The BIM Project Execution Planning Procedure can be adapted for multiple uses and situations beyond the original scope of the project. Even if project teams take only what they need from the procedure and do not complete the entire process, these projects can still create detailed BIM Plans. Teams have the ability to revise the template documents to fit their specific processes, without modifying any of the core steps of the planning procedure. These teams then have the ability to eventually add other portions of the procedure, which will further assist with their planning.

The BIM Project Execution Planning Procedure has helped project teams develop detailed plans for their projects. These plans outline the goals, process, information exchanges, and infrastructure for BIM implementation. By developing and following these plans, the teams are able to make a significant impact on the degree of successful BIM implementation. The procedure does take time and resources, particularly the first time an organization is involved in this level of planning, but the benefits of developing the detailed plan far outweigh the resources expended.

APPENDIX B – BIM USE DESCRIPTIONS

Please note that BIM Uses are organized in reference to Figure 2-2:

1. Building (Preventative) Maintenance Scheduling
2. Building System Analysis
3. Asset Management
4. Space Management and Tracking
5. Disaster Planning
6. Record Modeling
7. Site Utilization Planning
8. Construction System Design
9. Digital Fabrication
10. 3D Control and Planning
11. 3D Coordination
12. Design Authoring
13. Engineering Analysis
 - a. Energy Analysis
 - b. Structural Analysis
 - c. Lighting Analysis
 - d. Mechanical Analysis
 - e. Other Engineering Analysis
14. Sustainability (LEED) Evaluation
15. Code Validation
16. Programming
17. Site Analysis
18. Design Reviews
19. Phase Planning (4D Modeling)
20. Cost Estimation
21. Existing Conditions Modeling

B

Building (Preventative) Maintenance Scheduling

Description:

A process in which the functionality of the building structure (walls, floors, roof, etc) and equipment serving the building (mechanical, electrical, plumbing, etc) are maintained over the operational life of a facility. A successful maintenance program will improve building performance, reduce repairs, and reduce overall maintenance costs.

Potential Value:

- Plan maintenance activities proactively and appropriately allocate maintenance staff
- Track maintenance history
- Reduce corrective maintenance and emergency maintenance repairs
- Increase productivity of maintenance staff because the physical location of equipment/system is clearly understood
- Evaluate different maintenance approaches based on cost
- Allow facility managers to justify the need and cost of establishing a reliability centered maintenance program

Resources Required:

- Design review software to view Record Model and components
- Building Automation System (BAS) linked to Record Model
- Computerized Maintenance Management System (CMMS) linked to Record Model
- User-Friendly Dashboard Interface linked to Record Model to provide building performance information and/or other information to educate building users

Team Competencies Required:

- Ability to understand and manipulate CMMS and building control systems with Record Model
- Ability to understand typical equipment operation and maintenance practices
- Ability to manipulate, navigate, and review a 3D Model

Selected Resources:

- Campbell, D.A. (2007). BIM – Web Applications for AEC, Web 3D Symposium.
- Fallon, K. (2008). “Interoperability: Critical to Achieving BIM Benefits”. AIA Edges Website: Singh, H.; W.H. Dunn (2008). Integrating Facilities Stovepipes for Total Asset Management (TAM). Journal of Building Information Modeling, Spring 2008. http://www.aia.org/nwsltr_tap.cfm?pagename=tap_a_0704_interop
- ASHRAE (2003). HVAC design Manual for Hospitals and Clinics. Atlanta, GA. (2004). Federal energy Management Program. O&M Best Practices: A Guide to Achieving Operational Efficiency, Release 2.0. July 2004. www1.eere.energy.gov/femp/pds.OM_5.pdf
- Piotrowski, J. (2001). Pro-Active Maintenance for Pumps. Archives, February 2001, Pump-Zone.com

B

Building Systems Analysis

Description:

A process that measures how a building's performance compares to the specified design. This includes an analysis of the mechanical system operational characteristics including the energy use of a building. Other aspects of this analysis could include, but are not limited to, ventilated facade studies, lighting analysis, internal and external CFD airflow, and solar analysis.

Potential Value:

- Ensure building is operating to specified design and sustainable standards
- Identify opportunities to modify system operations to improve performance

Resources Required:

- 3D Model manipulation
- Building Systems Analysis Software (Energy, Lighting, Mechanical, Other)

Team Competencies Required:

- Ability to manipulate, navigate, and review a 3D model
- Ability to understand building systems and typical operations
- Ability to assess building systems using analysis software

Selected Resources:

- Ayat E. Osman, Robert Ries. " Optimization For Cogeneration Systems in Buildings Based on Life Cycle Assessment" May 2006, <http://itocn.org/2006/20/>
- "Building Performance Analysis Using Revit" 2007 Autodesk Inc., http://images.autodesk.com/adsk/files/building_performance_analysis_using_revit.pdf

Asset Management

Description:

A process in which an organized management system will efficiently aid in the maintenance and operation of a facility and its assets. These assets, consisting of the physical building, systems, surrounding environment, and equipment, must be maintained, operated, and upgraded at an efficiency which will satisfy both the owner and users at the lowest appropriate cost. It assists in financial decision-making, as well as short-term and long-term planning. Asset Management utilizes the data contained in a record model to determine cost implications of changing or upgrading building assets, segregate costs of assets for financial tax purposes, and maintain a current comprehensive database that can produce the value of a company's assets.

Potential Value:

- Store operations, maintenance owner user manuals, and equipment specifications.
- Perform and analyze facility and equipment condition assessments
- Maintain up-to-date facility and equipment data including, but not limited to, maintenance schedules, warranties, cost data, upgrades, replacements, damages/deterioration, maintenance records, manufacturer's data, equipment functionality, and others required by owner.
- Provide one comprehensive source for tracking the use, performance, and maintenance of a building's assets for the owner, maintenance team, and financial department
- Produce accurate inventory of current company assets which aids in financial reporting, bidding, and estimating the future cost implications of upgrades or replacements of a particular asset.
- Allow for future updates of record model to show current building asset information after upgrades, replacements, or maintenance by tracking changes
- Aid financial department in efficiently analyzing different types of assets through an increased level of visualization
- Increase the opportunity for measurement and verification of systems during building occupation

Resources Required:

- 3D Model manipulation
- Asset Management system

Team Competencies Required:

- Ability to manipulate, navigate, and review a 3D Model
- Ability to manipulate an asset management system
- Knowledge of tax requirements and related financial software
- Knowledge of construction and the operation of a building (replacements, upgrades, etc.)
- Knowledge of which assets require tracking, whether the building is dynamic vs. static, and the end needs of the building to satisfy the owner

Selected Resources:

- GSA Energy Performance and Operations: <http://www.gsa.gov/portal/content/102283>
- GSA Commissioning Overview: <http://www.gsa.gov/portal/content/104824>
- NIST **General Buildings Information Handover Guide: Principles, Methodology and Case Studies**
<http://www.fire.nist.gov/bfrlpubs/build07/PDF/b07015.pdf>

Space Management and Tracking

Description:

A process in which BIM is utilized to effectively allocate, manage, and track assigned workspaces and related resources. A BIM model will allow the facility management team to analyze the existing use of the space and appropriately manage changes in clientele, use of space, and future changes throughout the facility's life. Space management and tracking is an application of the record model.

Potential Value:

- Identify and allocate space for appropriate building use
- Track current use of space
- Insure optimum use of the facility's space resources
- Assist in planning future space needs for the facility

Resources Required:

- 3D Model manipulation
- Content management application

Team Competencies Required:

- Ability to manipulate, navigate, and review record model
- Ability to assess current space and assets and manage appropriately for future needs

Selected Resources:

- Valcik, Nicolas A. and Patricia Huesca-Dorantes. "Building a GIS Database for Space and Facilities Management." *New Directions for Institutional Research*, n120 p53-61 2003.

Disaster Planning

Description:

A process in which emergency responders would have access to critical building information in the form of a model and information system. The BIM would provide critical building information to the responders that would improve the efficiency of the response and minimize the safety risks. The dynamic building information would be provided by a building automation system (BAS), while the static building information, such as floor plans and equipment schematics, would reside in a BIM model. These two systems would be integrated via a wireless connection and emergency responders would be linked to an overall system. The BIM coupled with the BAS would be able to clearly display where the emergency was located within the building, possible routes to the area, and any other harmful locations within the building.

Potential Value:

- Provide police, fire, public safety officials, and first responders access to critical building information in real-time
- Improve the effectiveness of emergency response
- Minimize risks to responders

Resources Required:

- 3D Model manipulation
- Building Automation System (BAS) knowledge
- Emergency response knowledge

Team Competencies Required:

- Ability to manipulate, navigate, and review BIM model for facility updates
- Ability to understand dynamic building information through BAS
- Ability to make appropriate decisions during an emergency

Selected Resources:

- **Building Information for Emergency Responders.** Systemics, Cybernetics and Informatics, 11th World Multi-Conference (WMSCI 2007). Proceedings. Volume 3. Jointly with the Information Systems Analysis and Synthesis: ISAS 2007, 13th International Conference. July 8-11, 2007, Orlando, FL, Callaos, N.; Lesso, W.; Zinn, C. D.; Yang, H., Editor(s) (s), 1-6 pp, 2007. Treado, S. J.; Vinh, A.; Holmberg, D. G.; Galler, M.

B

Record Modeling

Description:

A process used to depict an accurate representation of the physical conditions, environment, and assets of a facility. The record model should, as a minimum, contain information relating to the main architectural and MEP elements. Additional information including equipment and space planning systems may be necessary if the owner intends to utilize the information. Furthermore, with the continuous updating and improvement of the record model and the capability to store more information, the model contains a true depiction of space with a link to information such as serial codes, warranties and maintenance history of all the components in the building. The record model also contains information linking pre-build specification to as-built specifications. This allows the owner to monitor the project relative to the specifications provided.

Potential Value:

- Aid in future modeling and 3D design coordination for renovation
- Provide documentation of environment for future uses, e.g., renovation or historical documentation
- Aid in the permitting process (e.g. continuous change vs. specified code.)
- Dispute elimination (e.g. link to contract with historical data highlights expectations and comparisons drawn to final product.)
- Solid understanding of project sequencing by stakeholders leads to reduced project delivery times, risk, cost, and law suits

Resources Required:

- 3D Model manipulation

Team Competencies Required:

- Ability to manipulate, navigate, and review 3D model
- Ability to use BIM modeling application for facility updates
- Ability to thoroughly understand site processes to ensure correct input

Selected Resources:

- http://www.bimforum.org/index.php?option=com_content&task=view&id=19#Q6
- <http://bentleybim.wordpress.com/2007/11/13/bentleys-bim-preferred-58-to-revit-38-executive-briefing/>
- <http://continuingeducation.construction.com/article.php?L=19&C=213&P=1>
- http://www.aecbytes.com/buildingthefuture/2006/Expotitions_meeting.html

Site Utilization Planning

Description:

A process in which a 4D model is used to graphically represent both permanent and temporary facilities on site, with the construction activity schedule. Additional information incorporated into the model can include labor resources, materials and associated deliveries, and equipment location. Because the 3D model components are directly linked to the schedule, site management functions such as visualized planning, short-term re-planning, and resources can be analyzed over different spatial and temporal data.

Potential Value:

- Generate site usage layout for temporary facilities, assembly areas, and material deliveries for all phases of construction
- Identify potential and critical space and time conflicts
- Select a feasible construction scheme
- Update site organization and space usage as construction progresses

Resources Required:

- 3D Model manipulation
- Design authoring software
- Scheduling software

Team Competencies Required:

- Ability to manipulate, navigate, and review 3D model
- Ability to manipulate and assess construction schedule with 3D model
- Ability to understand typical construction methods

Selected Resources:

- Chau, K.W.; M. Anson, and J.P. Zhang. "Four-Dimensional Visualization of Construction Scheduling and Site Utilization." *Journal of Construction Engineering and Management*. (July/August 2004): 598-606. *ASCE*. 5 September 2008. <http://cedb.asce.org/cgi/WWWdisplay.cgi?0410956>.
- Dawood, Nashwan et al. "The Virtual Construction Site (VIRCON) Tools: An Industrial Evaluation." *ITcon*. Vol. 10 (2005): 43-54. 8 September 2008. http://www.itcon.org/cgi-bin/works/Show?2005_5.
- Heesom, David and Lamine Mahdjoubi. "Trends of 4D CAD Applications for Construction Planning." *Construction Management and Economics*. (February 2004). 22 171-182. 8 September 2008. <http://www.tamu.edu/classes/choudhury/articles/1.pdf>.

Construction System Design (Virtual Mockup)

Description:

A process in which 3D System Design Software is used to design and analyze the construction of a complex building system (e.g. form work, glazing, tie-backs, etc.) in order to increase planning.

Potential Value:

- Increase constructability of a complex building system
- Increase construction productivity
- Increase safety awareness of a complex building system
- Decrease language barriers

Resources Required:

- 3D System design software

Team Competencies Required:

- Ability to manipulate, navigate, and review 3D model
- Ability to make appropriate construction decisions using a 3D System Design Software
- Knowledge of typical and appropriate construction practices for each component

Selected Resources:

- Leventhal, Lauren." Delivering Instruction for Inherently-3D Construction Tasks: Lessons and Questions for Universal Accessibility". Workshop on Universal Accessibility of Ubiquitous Computing: Providing for the elderly.
- Khemlano (2007). AECbytes: Building the Future (October 18, 2007).

Digital Fabrication

Description:

A process that utilizes machine technology to prefabricate objects directly from a 3D Model. The 3D Model is spooled into appropriate sections and inputted into fabrication equipment for production of system assemblies.

Potential Value:

- Automate building component fabrication
- Minimize tolerances through machine fabrication
- Maximize fabrication productivity

Resources Required:

- 3D Model manipulation
- Fabrication equipment
- Fabrication methods

Team Competencies Required:

- Ability to manipulate, navigate, and review a 3D model
- Ability to manufacture building components using digital information
- Ability to understand typical fabrication methods

Selected Resources:

- Rundell, Rick. "BIM and Digital Fabrication (1-2-3 Revit Tutorial)." http://www.cadalyst.com/aec/bim-and-digital-fabrication-1-2-3-revit-tutorial-3707_8 February 2008.

3D Control and Planning (Digital Layout)

Description:

A process that utilizes a model to layout the building assemblies and produce lift drawings. Lift drawings are 2D/3D component drawings used by foremen during on site construction.

Potential Value:

- Decrease layout error by producing control directly from the 3D Construction Model
- Increase communication between office and field personal
- Decrease/Eliminate language barriers

Resources Required:

- 3D Model manipulation

Team Competencies Required:

- Ability to manipulate, navigate, and review a 3D model
- Ability to understand and interpret lift drawings

Selected Resources:

- <http://www.construction-planning-and-control.com/>

3D Coordination

Description:

A process in which Clash Detection software is used during the coordination process to determine field conflicts by comparing 3D models of building systems. The goal of clash detection is to eliminate the major system conflicts prior to installation.

Potential Value:

- Coordinate building project through a model
- Reduce and eliminate field conflicts; which reduces RFI's significantly compared to other methods
- Visualize construction
- Increase productivity
- Reduced construction cost; potentially less cost growth (i.e. less change orders)
- Decrease construction time
- Increase productivity on site
- More accurate as built drawings

Resources Required:

- 3D Model manipulation
- Model Review application

Team Competencies Required:

- Ability to deal with people and project challenges
- Ability to manipulate, navigate, and review a 3D model
- Knowledge of BIM model applications for facility updates
- Knowledge of building systems.

Selected References:

- Staub-French S and Khanzode A (2007) ****3D and 4D Modeling for design and construction coordination: issues and lessons learned**** ITcon Vol. 12, pg. 381-407, <http://www.itcon.org/2007/26>
- Khanzode A, Fischer M, Reed D (2008) ****Benefits and lessons learned of implementing building virtual design and construction (VDC) technologies for coordination of mechanical, electrical, and plumbing (MEP) systems on a large healthcare project****, ITcon Vol. 13, Special Issue **Case studies of BIM use** , pg. 324-342, <http://www.itcon.org/2008/22>
- **AECbytes.com - venderhub**

Design Authoring

Description:

A process in which 3D software is used to develop a Building Information Model based on criteria that is important to the translation of the building's design. Two groups of applications that are at the core of the BIM-based design process are *design authoring tools* and *audit and analysis tools*.

Authoring tools create models while audit and analysis tools study or add to the richness of information in a model. Most of audit and analysis tools can be used for Design Review and Engineering Analysis BIM Uses. Design authoring tools are a first step towards BIM and the key is connecting the 3D model with a powerful database of properties, quantities, means and methods, costs and schedules.

Potential Value:

- Transparency of design for all stakeholders
- Better control and quality control of design, cost and schedule
- Powerful design visualization
- True collaboration between project stakeholders and BIM users
- Improved quality control and assurance

Resources Required:

- 3D Model manipulation

Team Competencies Required:

- Ability to manipulate, navigate, and review a 3D model
- Knowledge of construction means and methods
- Design and construction experience

Selected References:

- Tardif, M. (2008). BIM: Reaching Forward, Reaching Back. AIArchitect This Week. Face of the AIA. [AIArchitect](#)

Engineering Analysis (Structural, Lighting, Energy, Mechanical, Other)

Description:

A process in which intelligent modeling software uses the BIM model to determine the most effective engineering method based on design specifications. Development of this information is the basis for what will be passed on to the owner and/or operator for use in the building's systems (i.e. energy analysis, structural analysis, emergency evacuation planning, etc.). These analysis tools and performance simulations can significantly improve the design of the facility and its energy consumption during its lifecycle in the future.

Potential Value:

- Automating analysis and saving time and cost
- Analysis tools are less costly than BIM authoring tools, easier to learn and implement and less disruptive to established workflow
- Improve specialized expertise and services offered by the design firm
- Achieve optimum, energy-efficient design solution by applying various rigorous analyses
- Faster return on investment with applying audit and analysis tools for engineering analyses
- Improve the quality and reduce the cycle time of the design analyses

Resources Required:

- 3D Model manipulation
- Engineering analysis tools and software

Team Competencies Required:

- Ability to manipulate, navigate, and review a 3D Model
- Ability to assess a model through engineering analysis tools
- Knowledge of construction means and methods
- Design and construction experience

Selected References:

- Malin, N. (2008). BIM Companies Acquiring Energy Modeling Capabilities. <http://greensource.construction.com/news/080403BIMModeling.asp>
- Marsh, A. (2006). Ecotect as a Teaching Tool. <http://naturalfrequency.com/articles/ecotectasteacher>
- Marsh, A. (2006). Building Analysis: Work Smart, Not Hard. <http://naturalfrequency.com/articles/smartmodelling>
- Novitzki, B. (2008). Energy Modeling for Sustainability. <http://continuingeducation.construction.com/article.php?L=5&C=399>
- Stumpf, A., Brucker, B. (2008). BIM Enables Early Design Energy Analysis. <http://www.cecer.army.mil/td/tips/docs/BIM-EnergyAnalysis.pdf>
- PIER Building Program (2008). Estimating Energy Use Early and Often. www.esource.com/esource/getpub/public/pdf/cec/CEC-TB-13_EstEnergyUse.pdf
- Ecotect - Building Analysis for Designers. <http://www.cabs-cad.com/ecotect.htm>
- Khemlani (2007). AECbytes: Building the Future (October 18, 2007).

Sustainability (LEED) Evaluation

Description:

A process in which a project is evaluated based on LEED or other sustainable criteria. This can refer to materials, performance, or a process. Sustainability Evaluations can be applied across all four phases of a construction project, Planning, Design, Construction, and Operation. Sustainability evaluation is most effective when it is done in planning and design stages and then applied in the construction and operations phase. Model all sustainable aspects of a project throughout its life-cycle in order to obtain the desired LEED certification in the most efficient manner by condensing design analyses into a single database.

Potential Value:

- Accelerate design review and LEED certification process with efficient use of a single database with all the sustainable features present and archived
- Improved communication between project participants in order to achieve LEED credits and decreased redesign efforts as a result
- Align scheduling and material quantities tracking for more efficient material use and better cash flow analysis
- Optimize building performance by tracking energy use, indoor air quality and space planning for the adherence to LEED standards leading to integrated facility management using a BIM model

Resources Required:

- 3D Model manipulation
- LEED credit knowledge

Team Competencies Required:

- Ability to manipulate, navigate, and review a 3D model
- Knowledge of current LEED credit information

Selected Resources:

- Building Information Modeling for Sustainable Design: http://goliath.ecnext.com/coms2/gi_0199-7985352/Building-information-modeling-for-sustainable.html
- Sustainable Perspectives: Building Information Modeling for Sustainable Design: http://www.edcmag.com/Articles/Featured_Special_Sections/BNP_GUID_9-5-2006_A_1000000000000214529
- Building Information for Sustainable Design (Revit White Paper)
- Building Information Modeling and the Adoption of Green Technologies: <http://www.triplepundit.com/2008/05/building-information-modeling-and-the-adoption-of-green-technologies/>
- Krygiel, E., and Brad N. (2008). Green BIM: Successful Sustainable Design with Building Information Modeling. San Francisco: Sybex, 2008.

B

Code Validation

Description:

A process in which code validation software is utilized to check the model parameters against project specific codes. Code validation is currently in its infant stage of development within the U.S. and is not in widespread use. However, as model checking tools continue to develop, code compliance software with more codes, code validation should become more prevalent within the design industry.

Potential Value:

- Validate that building design is in compliance with specific codes, e.g. IBC International Building Code, ADA Americans with Disabilities Act guidelines and other project related codes using the 3D BIM model.
- Code validation done early in design reduces the chance of code design errors, omissions or oversights that would be time consuming and more expensive to correct later in design or construction.
- Code validation done automatically while design progresses gives continuous feedback on code compliance.
- Reduced turnaround time for 3D BIM model review by local code officials or reduced time that needs to be spent meeting with code commissioners, visiting the site, etc. or fixing code violations during punch list or closeout phase.
- Saves time on multiple checking for code compliance and allows for a more efficient design process since mistakes cost time and money.

Resources Required:

- Local code knowledge
- Model checking software
- 3D Model manipulation

Team Competencies Required:

- Ability to use BIM authoring tool for design and model checking tool for design review
- Ability to use code validation software and previous knowledge and experience with checking codes is needed.

Selected Resources:

- [Automated Circulation Validation using BIM](#). GSA. 1-22.
- Eastman, C., Liston, K., Sacks, R. and Teicholz, P. [BIM Handbook: A Guide to Building Information Modeling for Owners, Managers, Designers, Engineers and Contractors](#). New York, NY: Wiley, 2008.

Design Reviews

Description:

A process in which a 3D model is used to showcase the design to the stakeholders, evaluate meeting the program, and set criteria such as layout, sightlines, lighting, security, ergonomics, acoustics, textures and colors, etc. Virtual mock-ups can be done in high detail even on a part of the building like a façade to quickly analyze design alternatives and solve design and constructability issues. If properly executed, these reviews can resolve design issues by offering different options. Additionally design reviews reduce the cost and time invested in traditional mock-ups considering basic construction, making modifications after reviews and final demolition and removal expense.

Potential Value:

- Eliminate costly and timely traditional construction mock-ups
- Different design options and alternatives are easy to model and change real-time during design review by end users or owner
- Create shorter and more efficient design reviews
- Resolve the conflicts that would arise in a mock-up and model the potential fixes in real-time along with tolerances revised and RFI's answered
- Preview space aesthetics and layout during design review in a virtual environment
- Evaluate effectiveness of design in meeting building program criteria and owner's needs
- Creates efficiencies in design process
- Easily communicate the design to the owner, construction team and end users. Get instant feedback on meeting program requirements, owner's needs and building or space aesthetics

Resources Required:

- 3D Model manipulation
- Design Review Software
- Interactive review space

Team Competencies Required:

- Ability to manipulate, navigate, and review a 3D model
- Ability to model photo realistically including textures, colors and finishes and easily navigable by using different software or plug-ins.

Selected Resources:

- Dunston, Phillip S., Arns, Laura L., and McGlothin, James D. (2007). "An Immersive Virtual Reality Mock-up for Design Review of Hospital Patient Rooms," 7th International Conference on Construction Applications of Virtual Reality, University Park, Pennsylvania, October 22-23, 9 pages
- Majumdar, Tulika, Fischer, Martin A., and Schwegler, Benedict R. (2006). "Conceptual Design Review with a Virtual Reality Mock-Up Model," Building on IT: Joint International Conference on Computing and Decision Making in Civil and Building Engineering, Hugues Rivard, Edmond Miresco, and Hani Melham, editors, Montreal, Canada, June 14-16, 2902-2911.
- Maldovan, Kurt D., Messner, John I., and Faddoul, Mera (2006). "Framework for Reviewing Mockups in an Immersive Environment," CONVR 2006: 6th International Conference on Construction Applications of Virtual Reality, R. Raymond Issa, editor, Orlando, Florida, August 3-4, on CD, 6 pages

Programming

Description:

A process in which a spatial program is used to efficiently and accurately assess design performance in regard to spatial requirements. The developed BIM model allows the project team to analyze space and understand the complexity of space standards and regulations. Critical decisions are made in this phase of design and bring the most value to the project when needs and options are discussed with the client and the best approach is analyzed.

Potential Value:

- Efficient and accurate assessment of design performance in regard to spatial requirements by the owner.

Resources Required:

- Design Authoring Software

Team Competencies Required:

- Ability to manipulate, navigate, and review a 3D model

Selected Resources:

- GSA BIM Guide

Site Analysis

Description:

A process in which BIM/GIS tools are used to evaluate properties in a given area to determine the most optimal site location for a future project. The site data collected is used to first select the site and then position the building based on other criteria.

Potential Value:

- Use calculated decision making to determine if potential sites meet the required criteria according to project requirements, technical factors, and financial factors
- Decrease costs of utility demand and demolition
- Increase energy efficiency
- Minimize risk of hazardous material
- Maximize return on investment

Resources Required:

- GIS software
- 3D Model manipulation

Team Competencies Required:

- Ability to manipulate, navigate, and review a 3D model
- Knowledge and understanding of local authority's system (GIS, database information)

Selected Resources:

- **The Site Selection Guide.** US General Services Administration (GSA) Public Building Service.
- Optimal Site Selection for Military Land Management, R.M. Wallace, ASCE Conf. Proc. 138, 159 (2004). DOI: 10. 1061/40737(2004)159.
- Farnsworth, Stephen J. "Site Selection Perspective." Prospecting Sites. June 1995, 29-31.
- WPBG Sustainable Committee. **Optimizing Site Potential.**
- Suermann P.C. Leveraging GIS Tools in Defense and Response at the U.S. Air Force Academy. ASCE Conf. Proc. 179, 82 (2005) DOI: 10. 1061/40794(179)82.
- GIS – Based Engineering Management Service Functions: Taking GIS Beyond Mapping for Municipal Governments.

B

Phase Planning (4D Modeling)

Description:

A process in which a 4D model (3D models with the added dimension of time) is utilized to effectively plan the phased occupancy in a renovation, retrofit, addition, or to show the construction sequence and space requirements on a building site. 4D modeling is a powerful visualization and communication tool that can give a project team, including the owner, a better understanding of project milestones and construction plans.

Potential Value:

- Better understanding of the phasing schedule by the owner and project participants and showing the critical path of the project
- Dynamic phasing plans of occupancy offering multiple options and solutions to space conflicts
- Integrate planning of human, equipment and material resources with the BIM model to better schedule and cost estimate the project
- Space and workspace conflicts identified and resolved ahead of the construction process
- Marketing purposes and publicity
- Identification of schedule, sequencing or phasing issues
- More readily constructible, operable and maintainable project
- Monitor procurement status of project materials
- Increased productivity and decreased waste on job sites
- Conveying the spatial complexities of the project, planning information, and support conducting additional analyses

Resources Required:

- 3D Model manipulation
- Scheduling software
- 4D Modeling Software

Team Competencies Required:

- Knowledge of construction scheduling and general construction process. A 4D model is connected to a schedule, and is therefore only as good as the schedule to which it is linked.
- Ability to manipulate, navigate, and review a 3D model.
- Knowledge of 4D software: import geometry, manage links to schedules, produce and control animations, etc.

Selected Resources:

- Dawood, N., and Mallasi, Z. (2006). Construction Workplace Planning: Assignment and Analysis Utilizing 4D Visualization Technologies. *Computer-aided Civil and Infrastructure Engineering*, Pgs. 498-513.
- Jongeling, R., Kim, J., Fischer, M., Morgeous, C., and Olofsson, T. (2008). Quantitative analysis of workflow, temporary structure usage, and productivity using 4D models. *Automation in Construction*, Pgs. 780-791.
- Kang, J. H., Anderson, S. D., and Clayton, M. J. (2007). Empirical Study on the Merit of Web-based 4D Visualization in Collaborative Construction Planning and Scheduling. *Journal of Construction Engineering and Management*, Pgs. 447-461.

Cost Estimation

Description:

A process in which a BIM model can be used to generate an accurate quantity take-off and cost estimate early in the design process and provide cost effects of additions and modifications with potential to save time and money and avoid budget overruns. This process also allows designers to see the cost effects of their changes in a timely manner which can help curb excessive budget overruns due to project modifications.

Potential Value:

- Precisely estimate material quantities and generate quick revisions if needed
- Stay within budget constraints with frequent preliminary cost estimate while the design progresses
- Better visual representation of project and construction elements that need to be estimated: taken off and priced
- Provide cost information to the owner during the early decision making phase of design
- Focus on more value adding activities in estimating like identifying construction assemblies, generating pricing and factoring risks then quantity take-off, which are essential for high quality estimates.
- Exploring different design options and concepts within the owner's budget
- Saving estimator's time and allowing them to focus on more important issues in an estimate since take-offs can be automatically provided.
- Quickly determine costs of specific objects

Resources Required:

- Model-based estimating software
- Design authoring software
- Cost data

Team Competencies Required:

- Ability to define specific design modeling procedures which yield accurate quantity take-off information
- Ability to identify quantities for the appropriate estimating level (e.g. ROM, SF, etc.) upfront

Selected Resources:

- Lee, H., Lee, Kim, J. (2008). **A cost-based interior design decision support system for large-scale housing projects**, ITcon Vol. 13, Pg. 20-38, <http://www.itcon.org/2008/2>
- Autodesk Revit. "BIM and Cost Estimating." Press release. Jan. 2007. Autodesk. 11 Sept. 2008. http://images.autodesk.com/adsk/files/bim_cost_estimating_jan07_1_.pdf
- Dean, R. P., and McClendon, S. (2007). "Specifying and Cost Estimating with BIM." **ARCHI TECH**. Apr. 2007. ARCHI TECH. 13 Sept. 2008. http://www.architechmag.com/articles/detail.aspx?contentid=3624_
- Khemlani, L. (2006). "Visual Estimating: Extending BIM to Construction." **AEC Bytes**. 21 Mar. 2006. 13 Sept. 2008. <http://www.aecbytes.com/buildingthefuture/2006/visualestimating.html>
- Buckley, B. (2008). "BIM Cost Management." **California Construction**. June 2008. 13 Sept. 2008.
- Manning, R.; Messner, J. (2008). **Case studies in BIM implementation for programming of healthcare facilities**, ITcon Vol. 13, Special Issue **Case studies of BIM use**, Pg. 246-257, <http://www.itcon.org/2008/18>

Existing Conditions Modeling

Description:

A process in which a project team develops a 3D model of the existing conditions for a site, facilities on a site, or a specific area within a facility. This model can be developed in multiple ways depending on what is desired and what is most efficient. Once the model is constructed, it can be queried for information, whether it is for new construction or a modernization project.

Potential Value:

- Document existing building for historical use
- Provide documentation of environment for future uses
- Enhance efficiency and accuracy of existing conditions documentation
- Provide location information
- Aids in future modeling and 3D design coordination
- Use for visualization purposes

Resources Required:

- 3D Model manipulation
- 3D Laser scanning
- 3D Laser scanning point cloud translation into objects

Team Competencies Required:

- Ability to manipulate, navigate, and review a 3D model
- Knowledge of BIM authoring tools
- Knowledge of 3D laser scanning tools

Selected Resources:

- GSA BIM Guide Series 3. [3D Laser Scanning](#).

APPENDIX C – BIM USE ANALYSIS WORKSHEET

BIM Use*	Value to Project High / Med / Low	Responsible Party	Value to Resp Party High / Med / Low	Capability Rating			Additional Resources / Competencies Required to Implement	Notes	Proceed with Use YES / NO / MAYBE
				Resources	Competency	Experience			
Maintenance Scheduling									
Building Systems Analysis									
Record Modeling									
Cost Estimation									
4D Modeling									
Site Utilization Planning									
Layout Control & Planning									
3D Coordination (Construction)									
Engineering Analysis									
Site Analysis									
Design Reviews									
3D Coordination (Design)									
Existing Conditions Modeling									
Design Authoring									
Programming									
* Additional BIM Uses as well as information on each Use can be found at http://www.engr.psu.edu/ae/cic/bimex/									

C

APPENDIX D – TEMPLATE PROCESS MAPS

This appendix contains the following BIM Process Map Templates:

Level 1: BIM Overview Map

Level 2: Detailed BIM Use Process Maps:

1. Existing Conditions Modeling
2. Cost Estimation
3. 4D Modeling
4. Programming
5. Site Analysis
6. Design Reviews
7. Design Authoring
8. Energy Analysis
9. Structural Analysis
10. Lighting Analysis
11. 3D Design Coordination
12. Site Utilization Planning
13. 3D Control and Planning
14. Record Modeling
15. Maintenance Scheduling
16. Building System Analysis

D

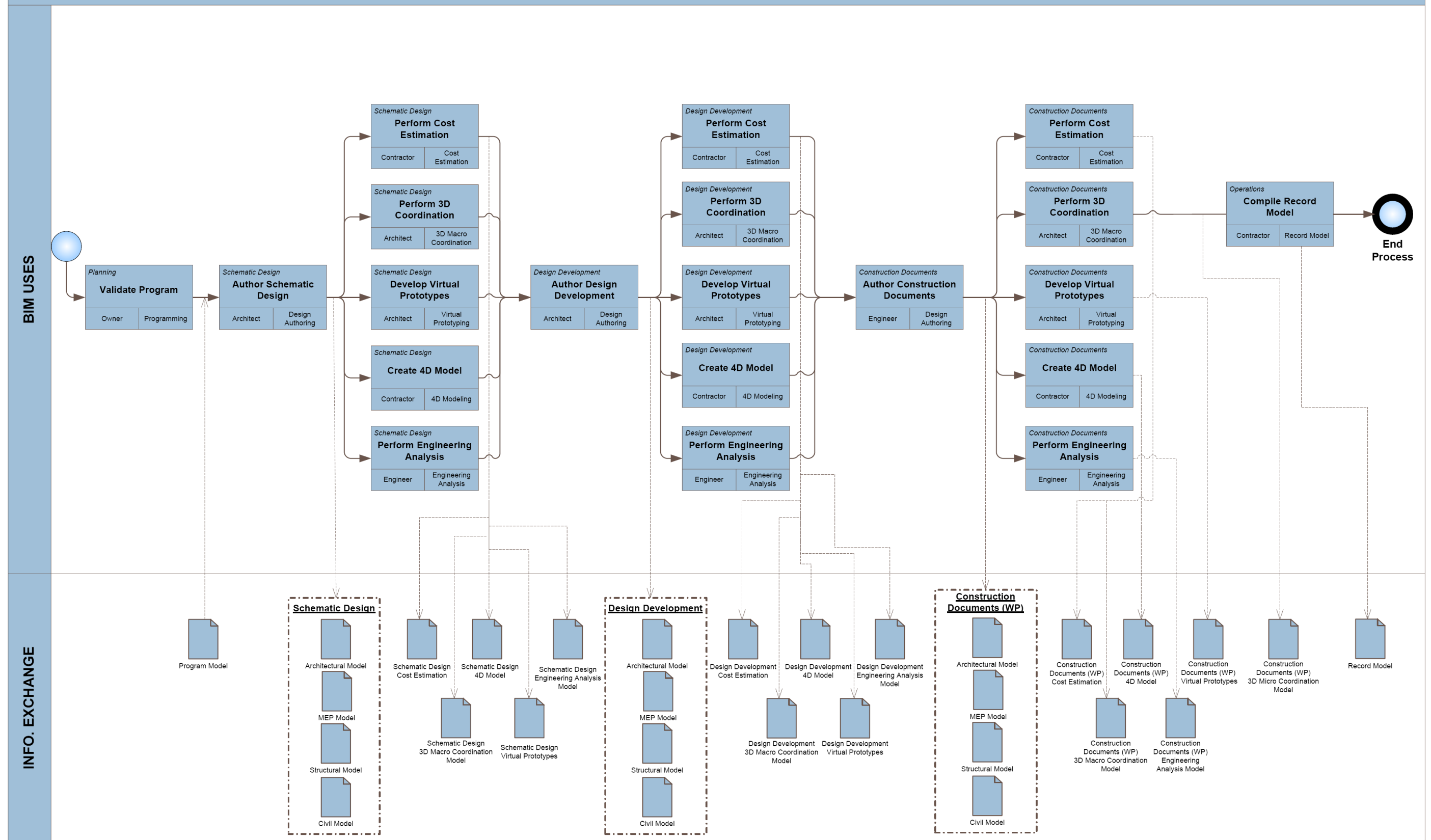

D

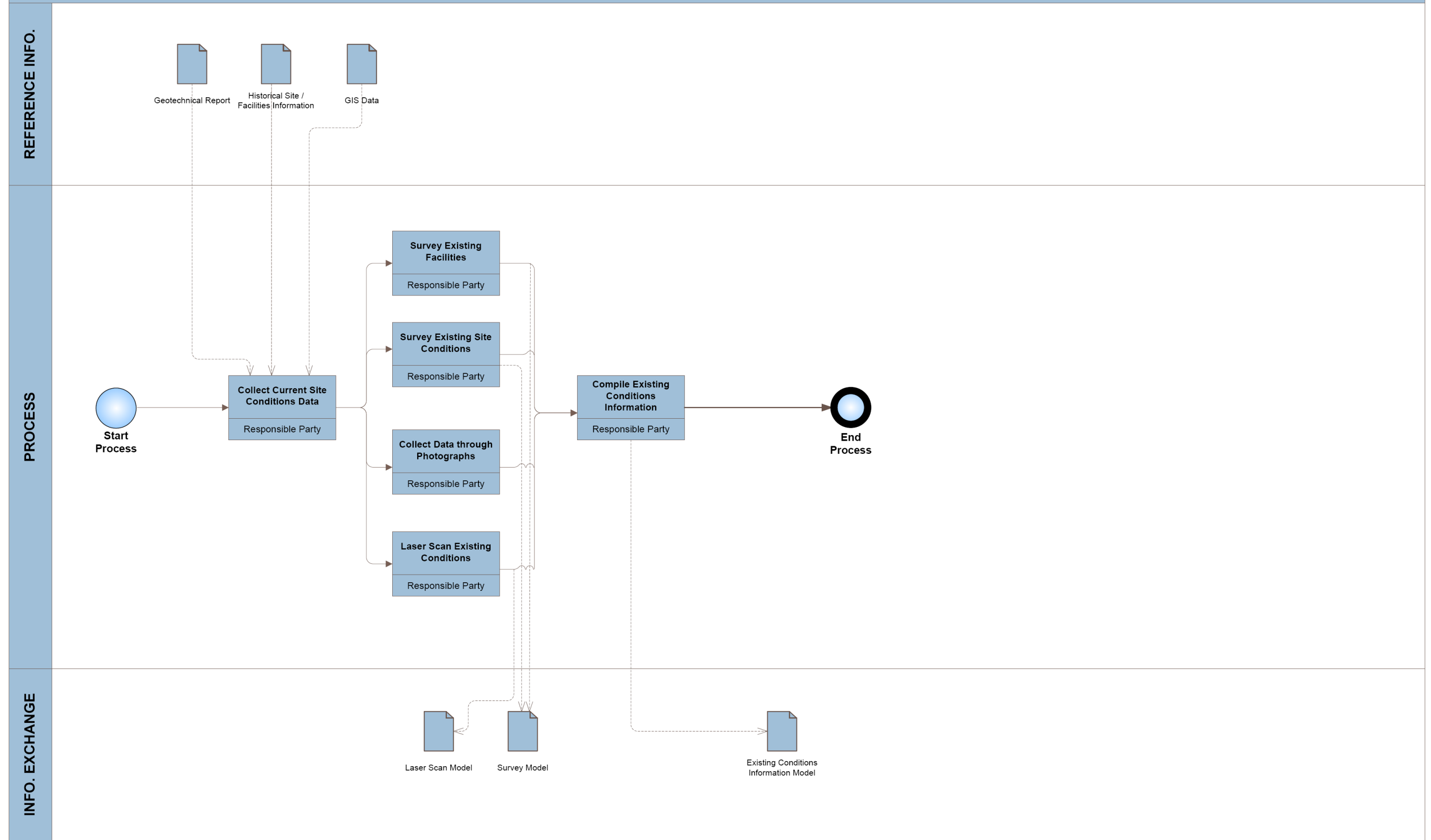

D

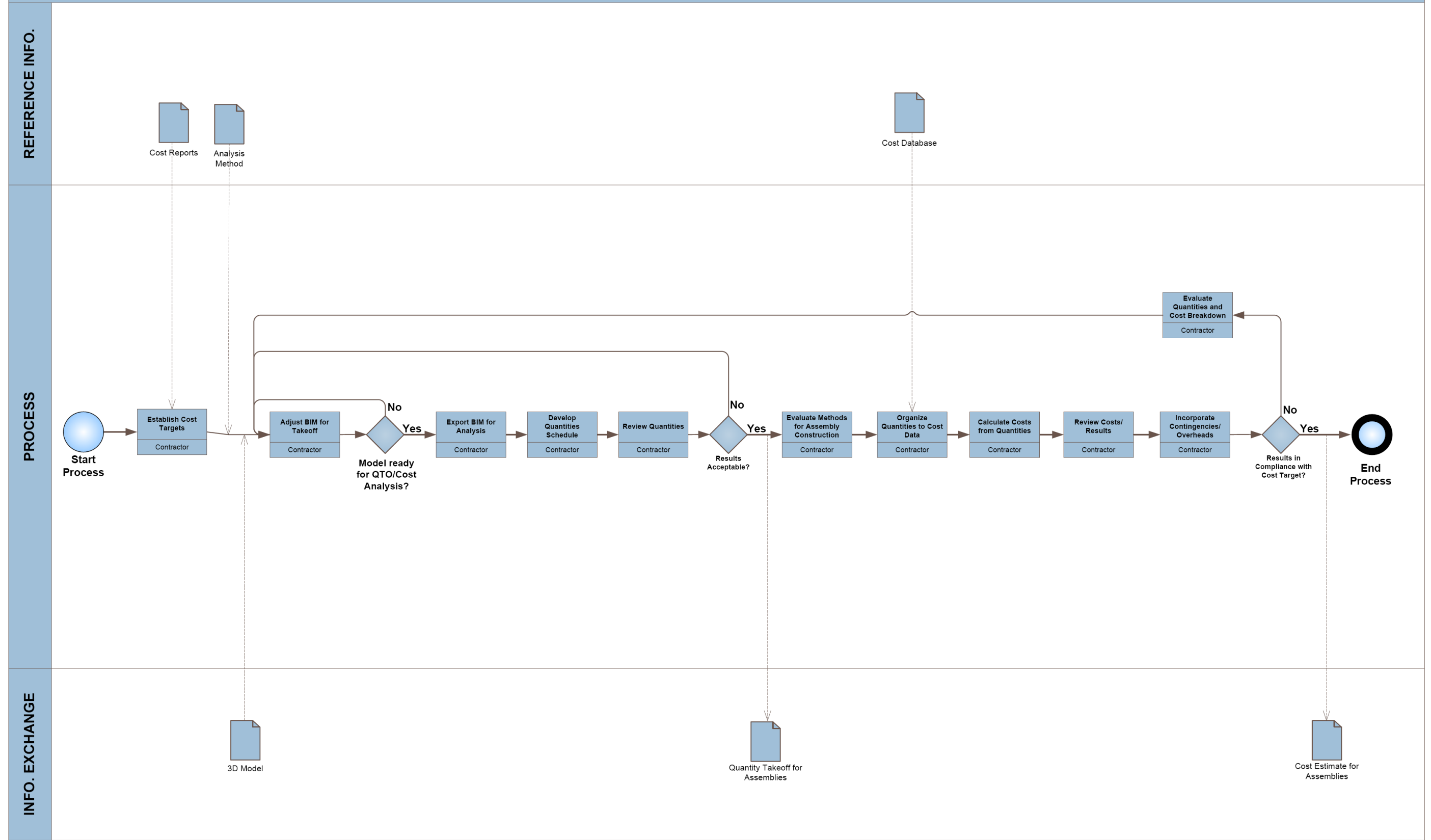

D

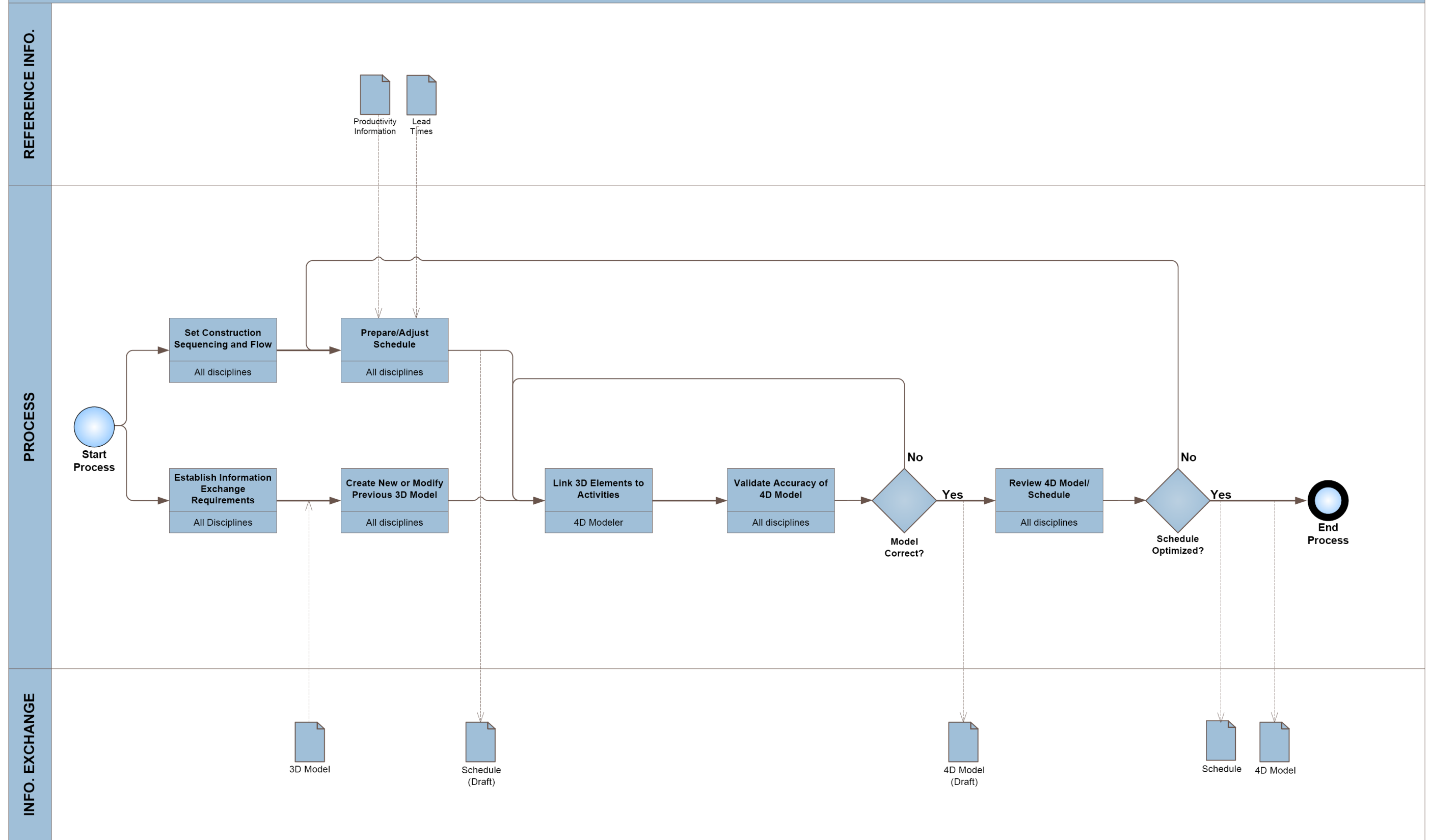

D

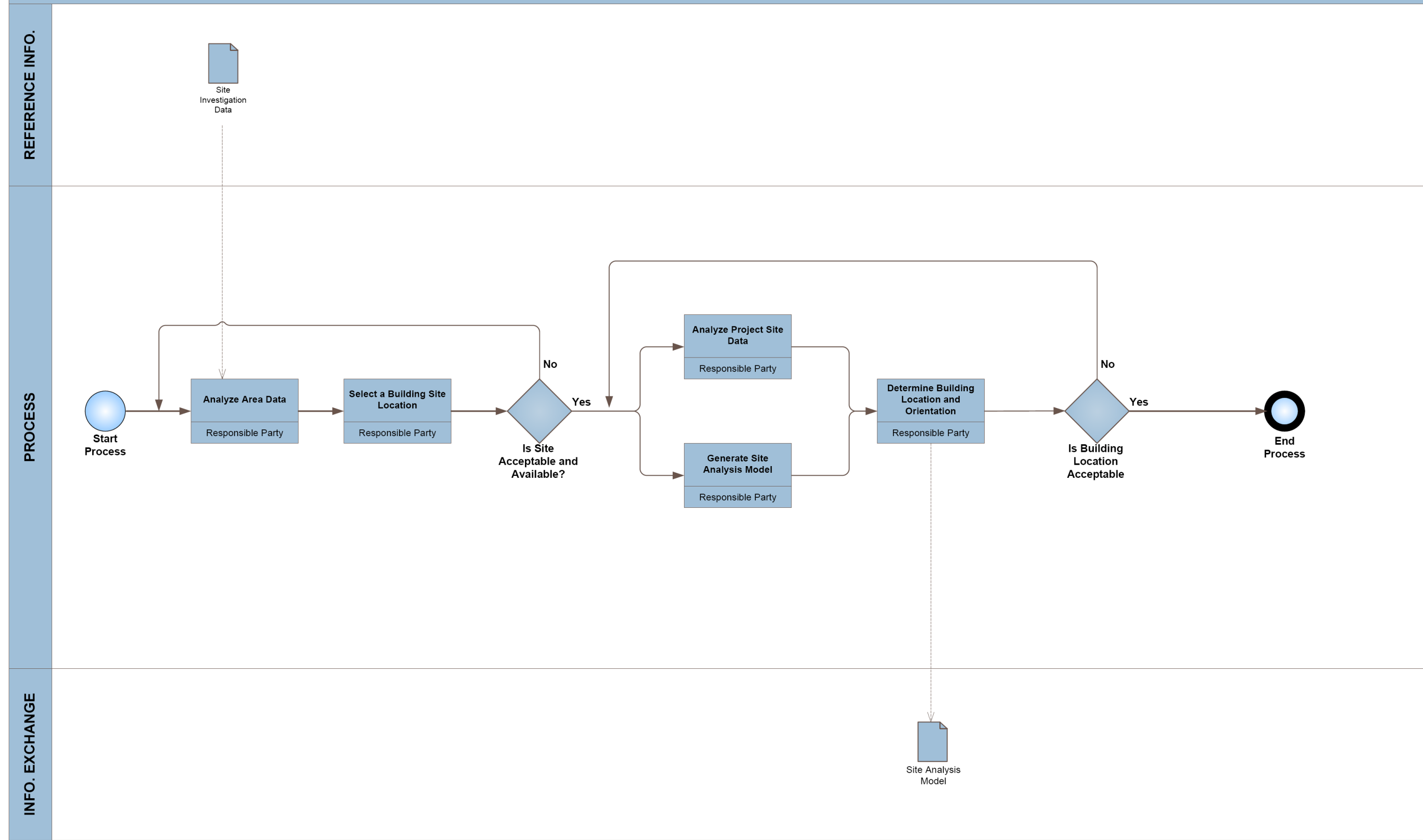

D

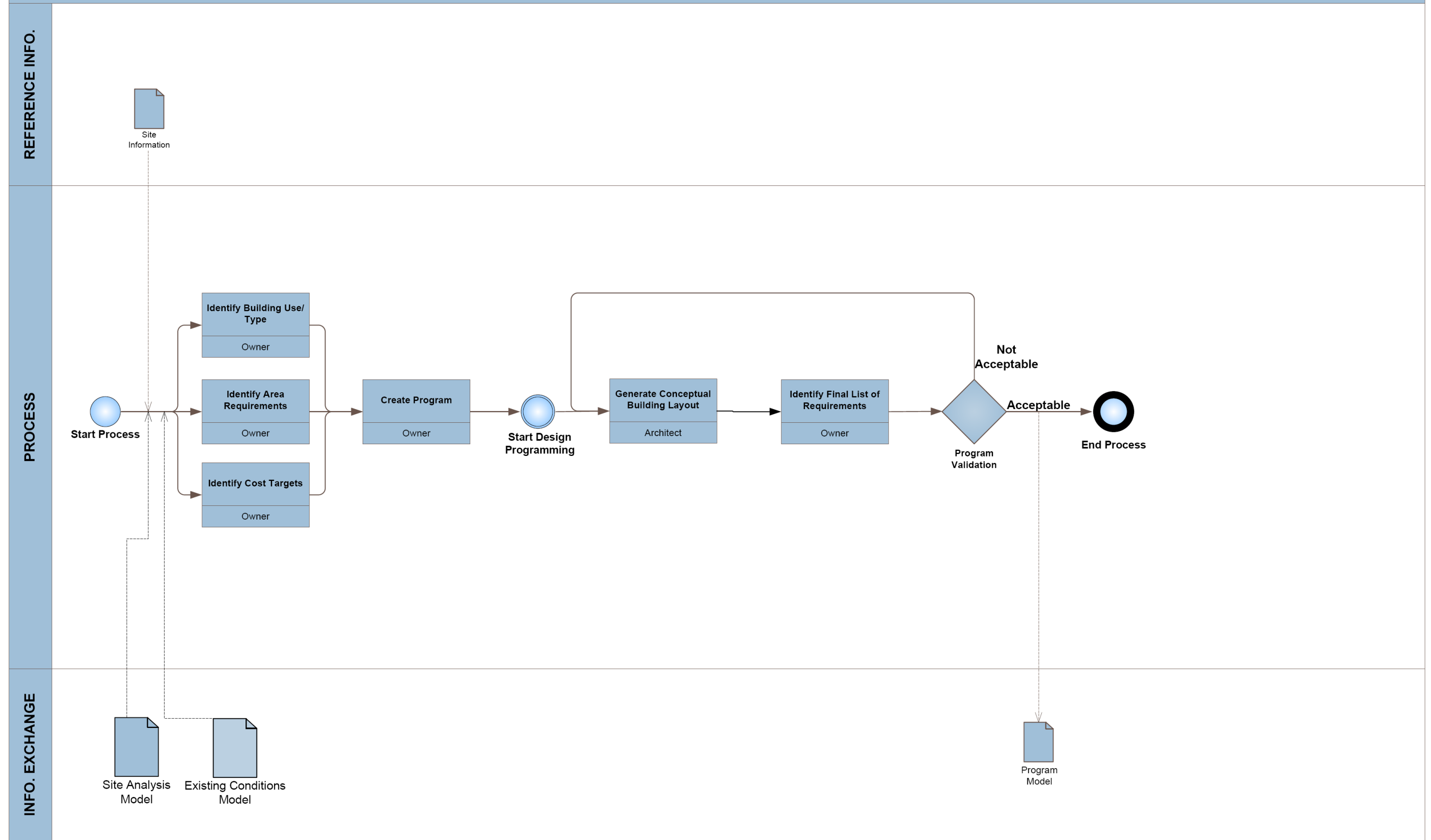

D

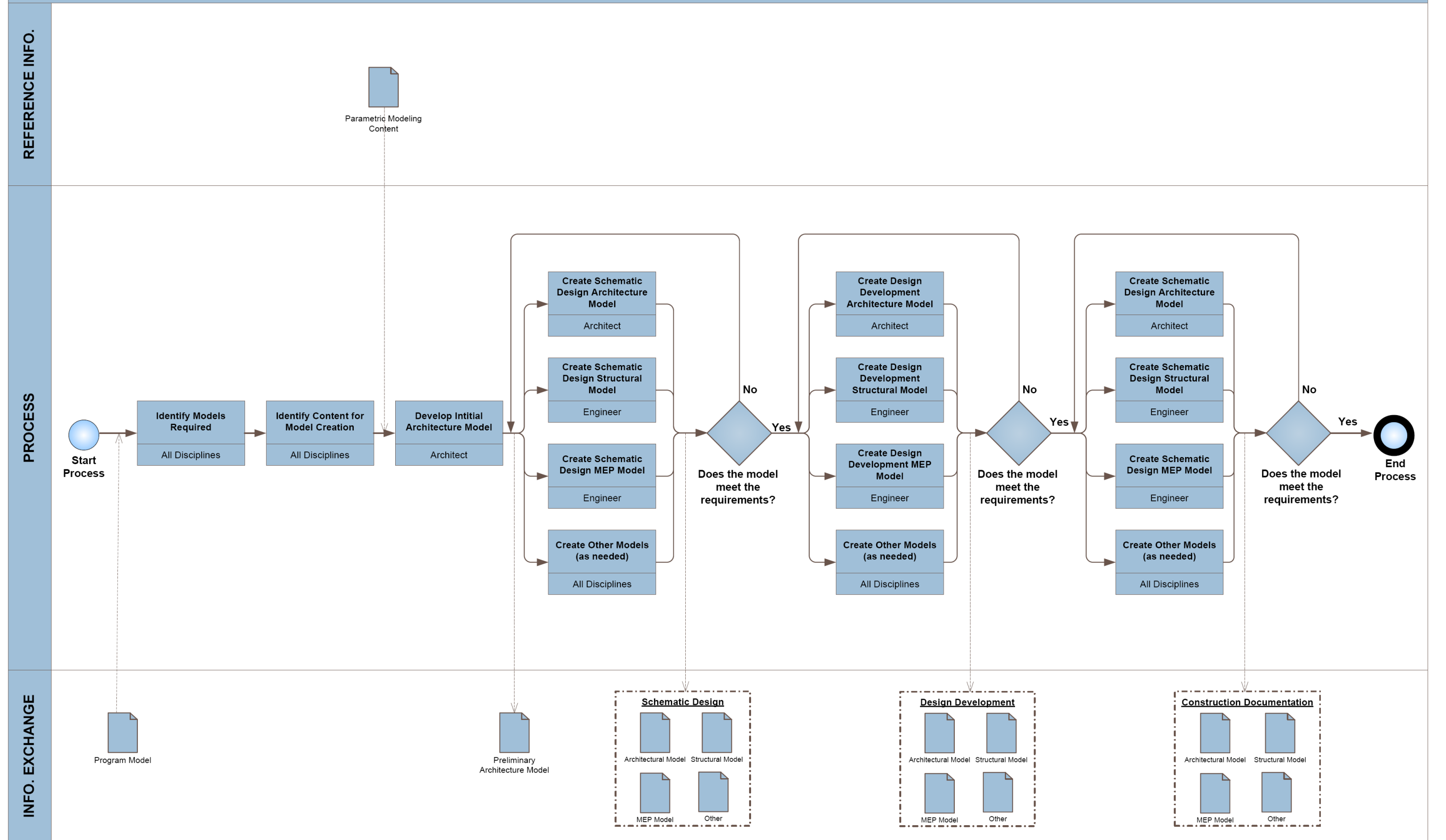

D

REFERENCE INFO.

PROCESS

INFO. EXCHANGE

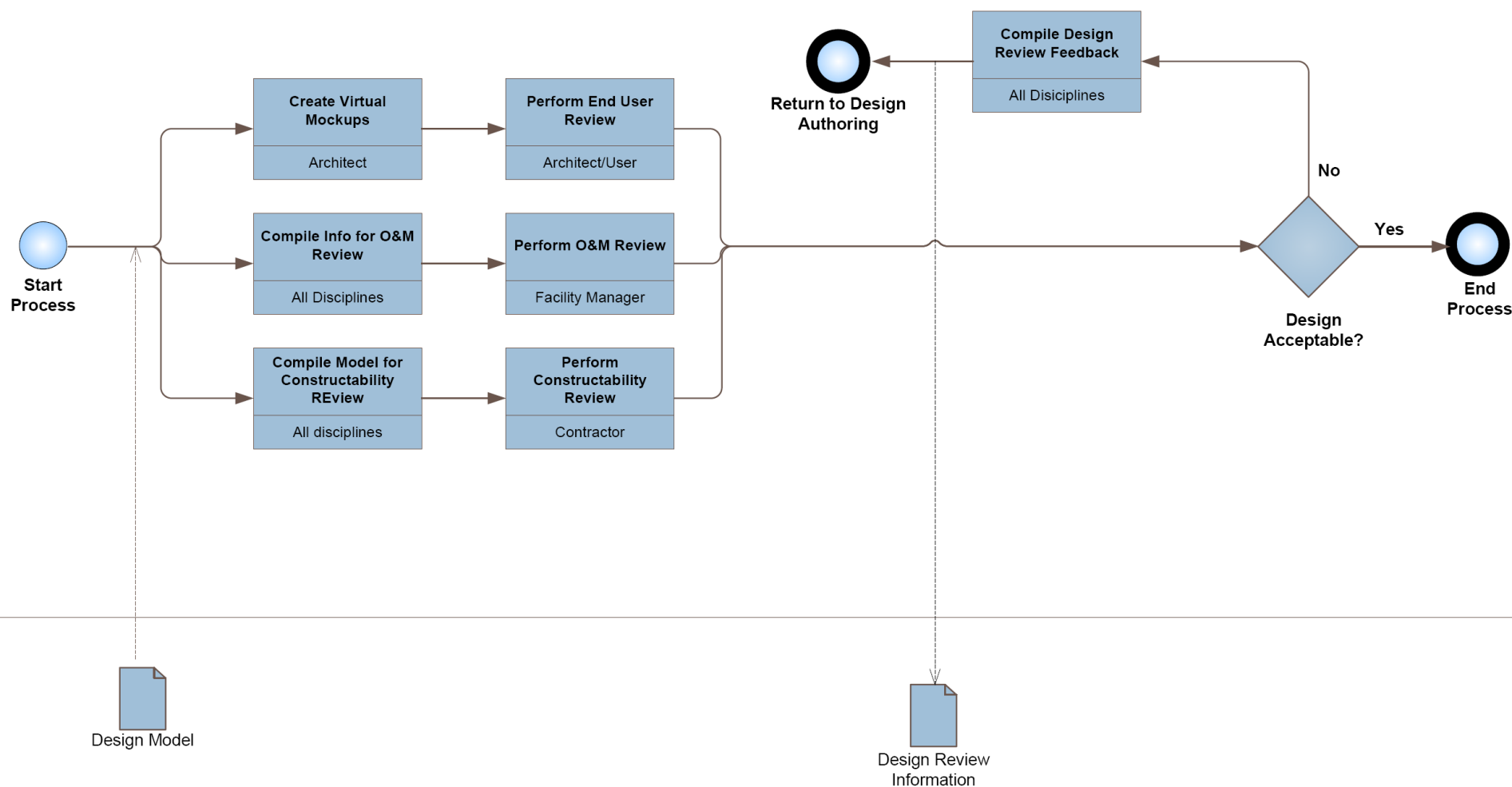

D

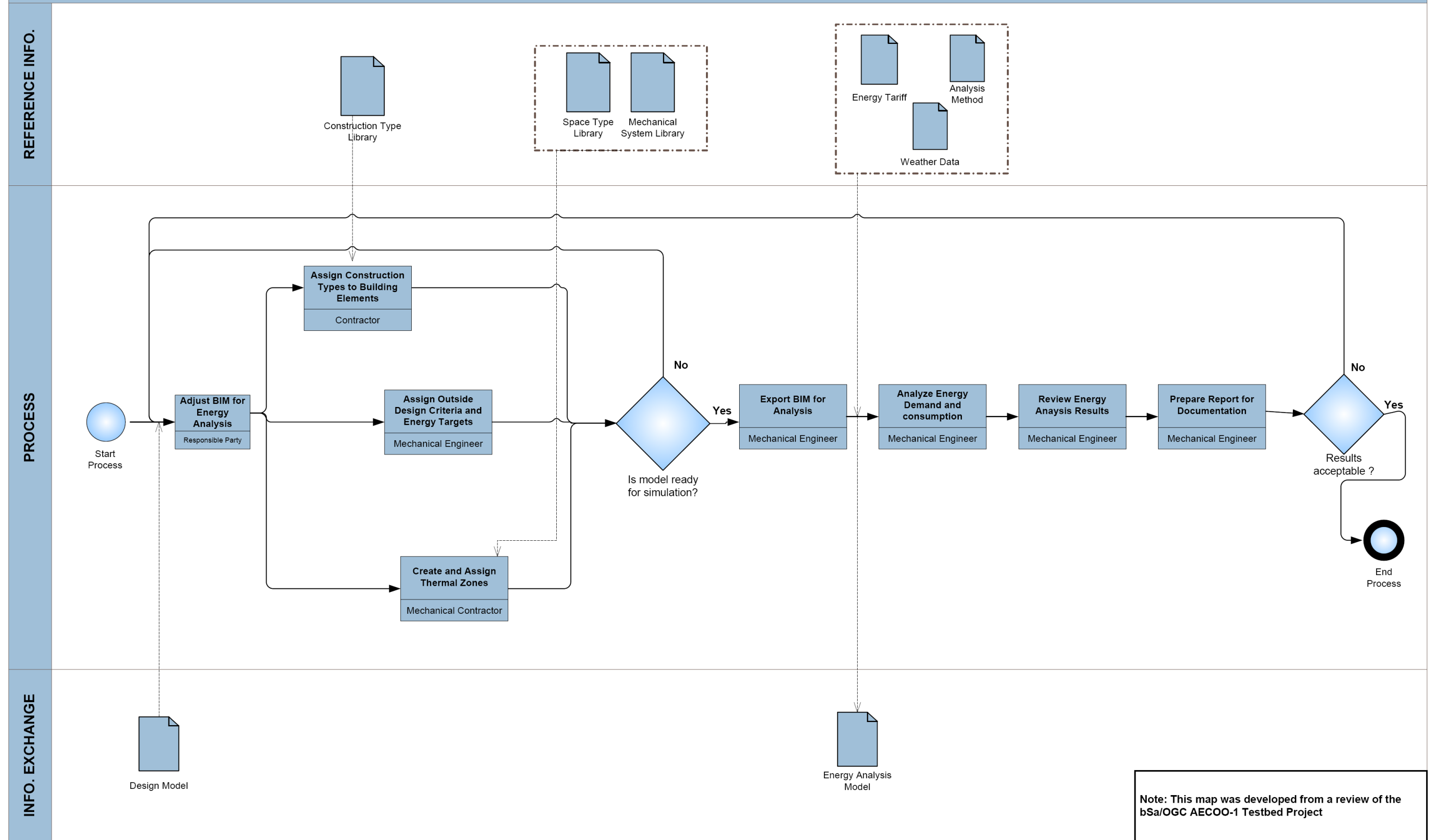

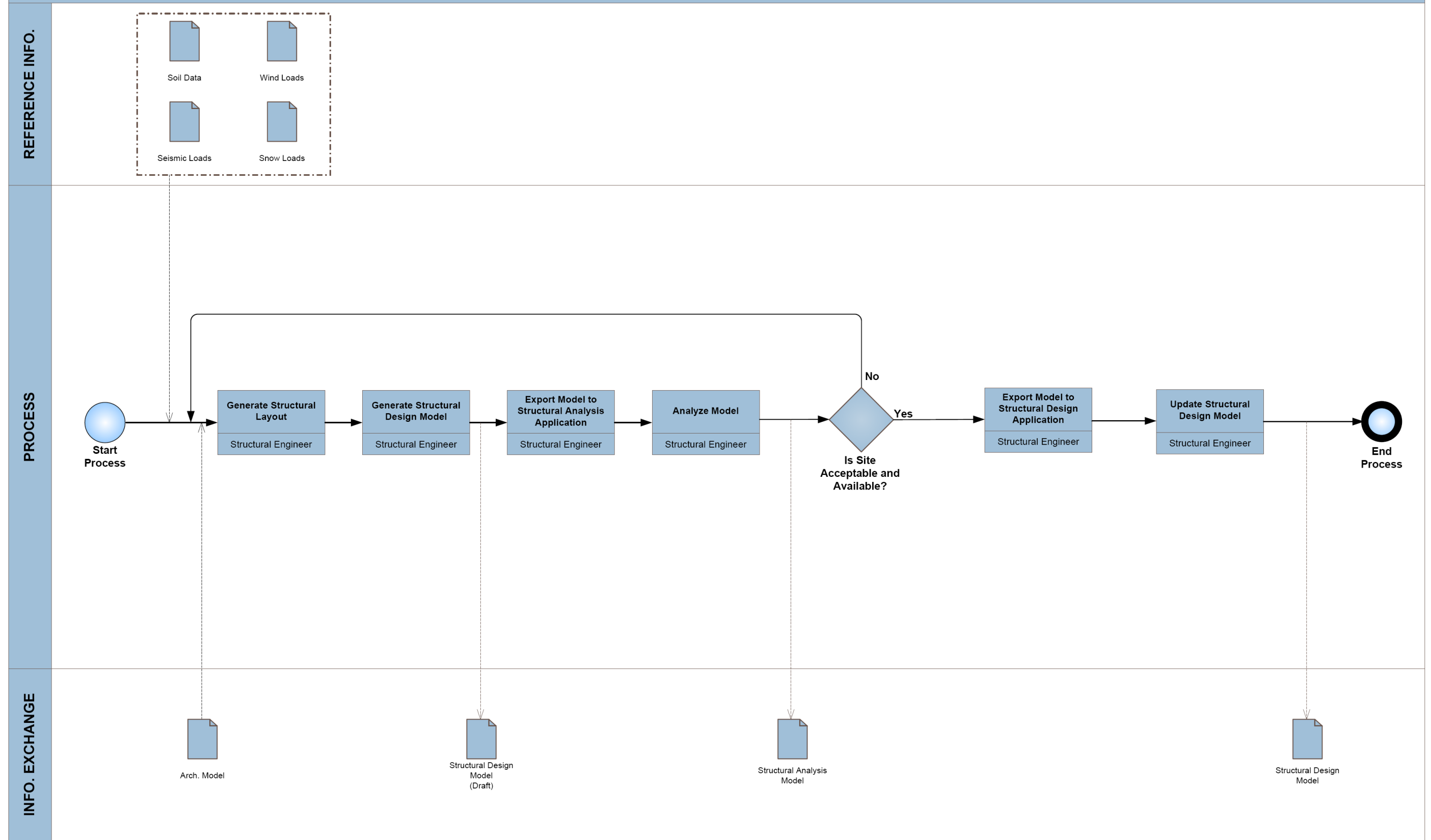

D

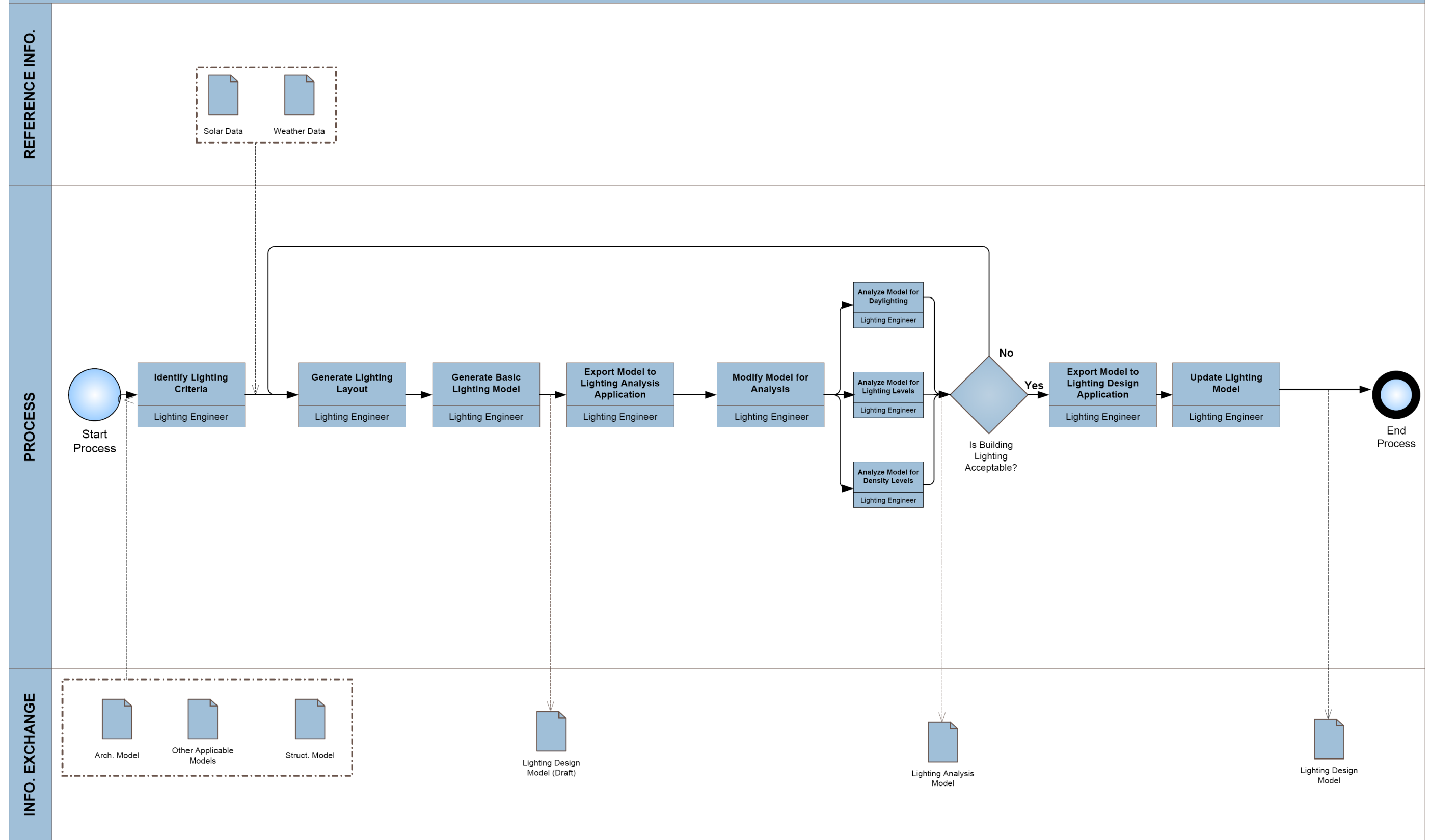

D

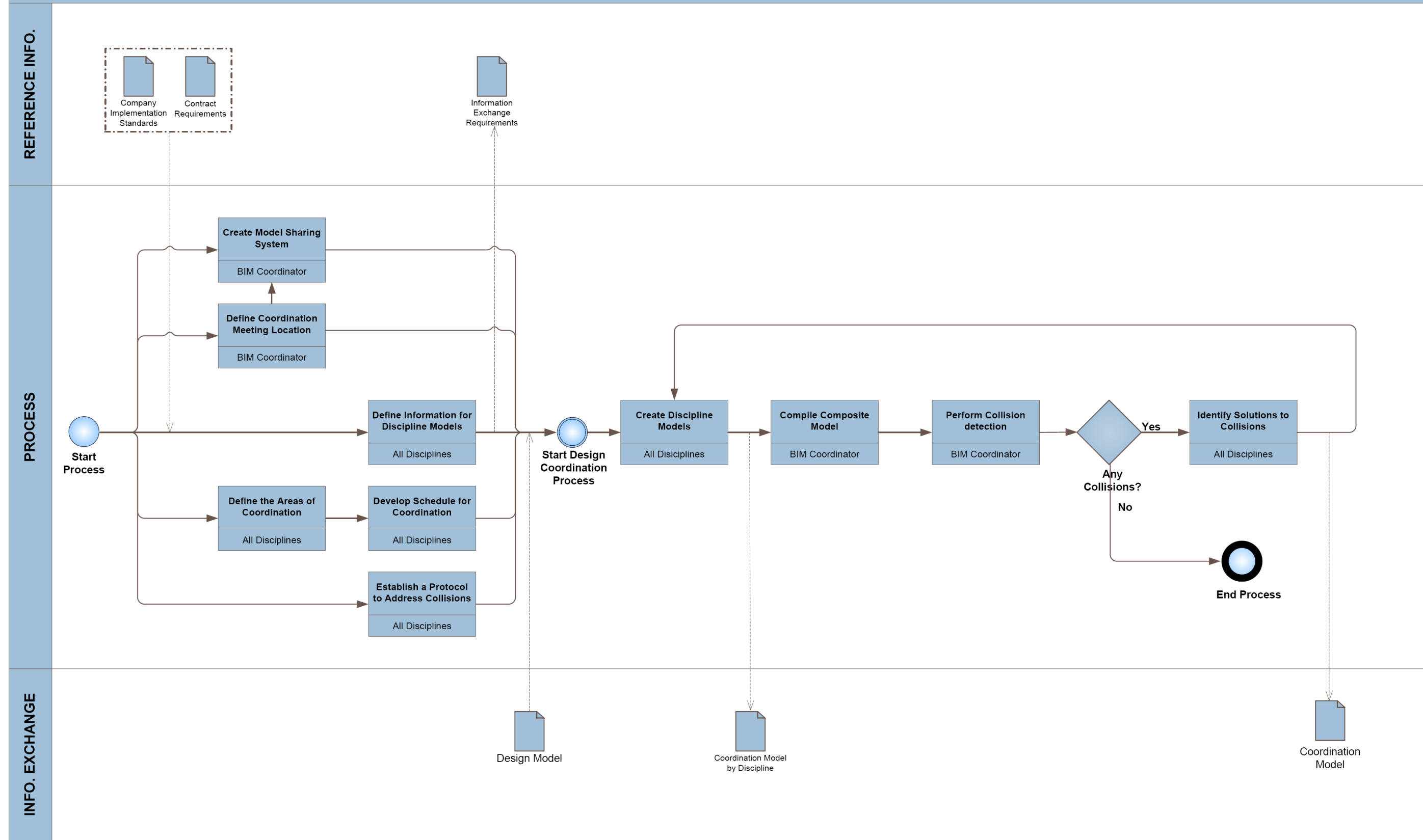

D

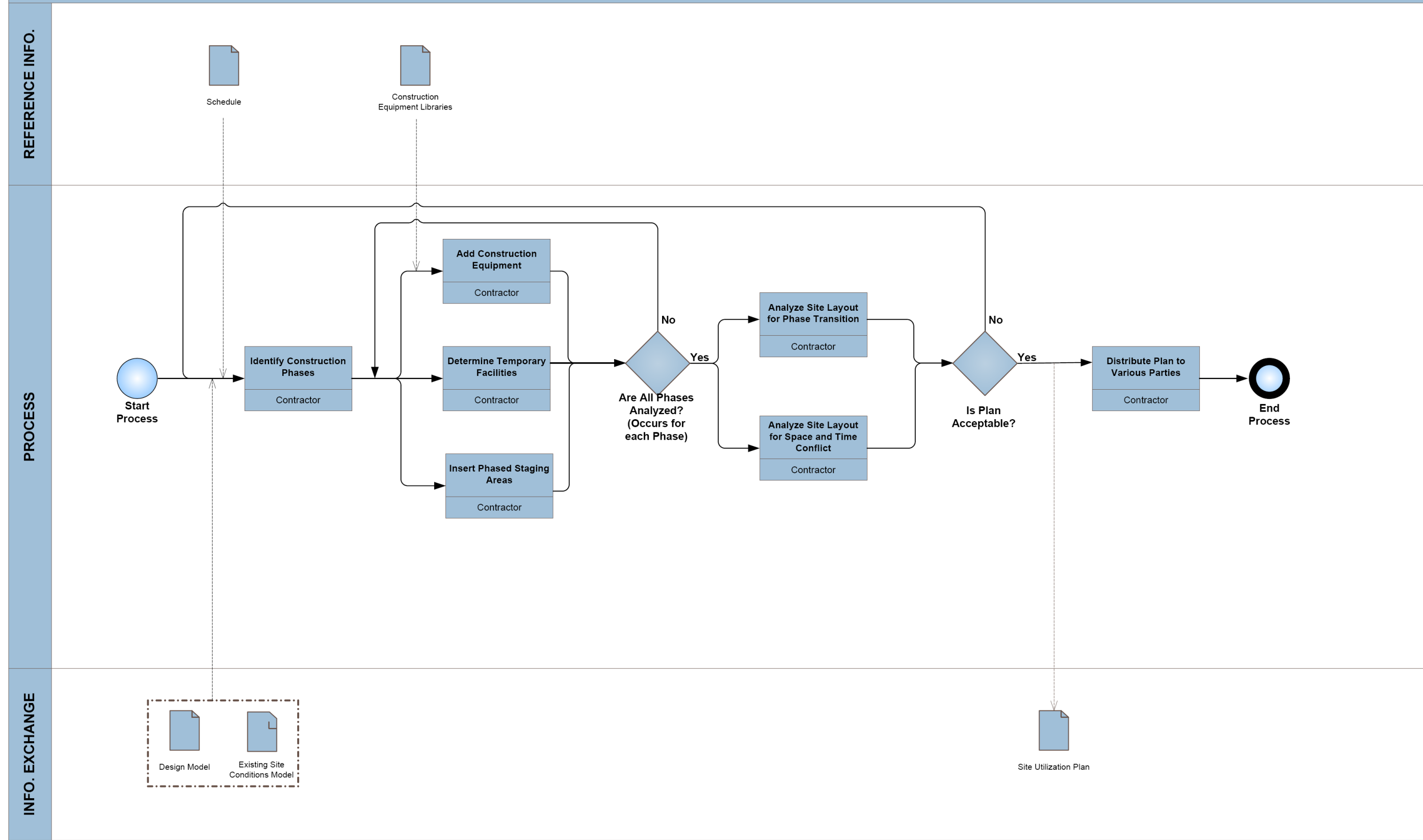

D

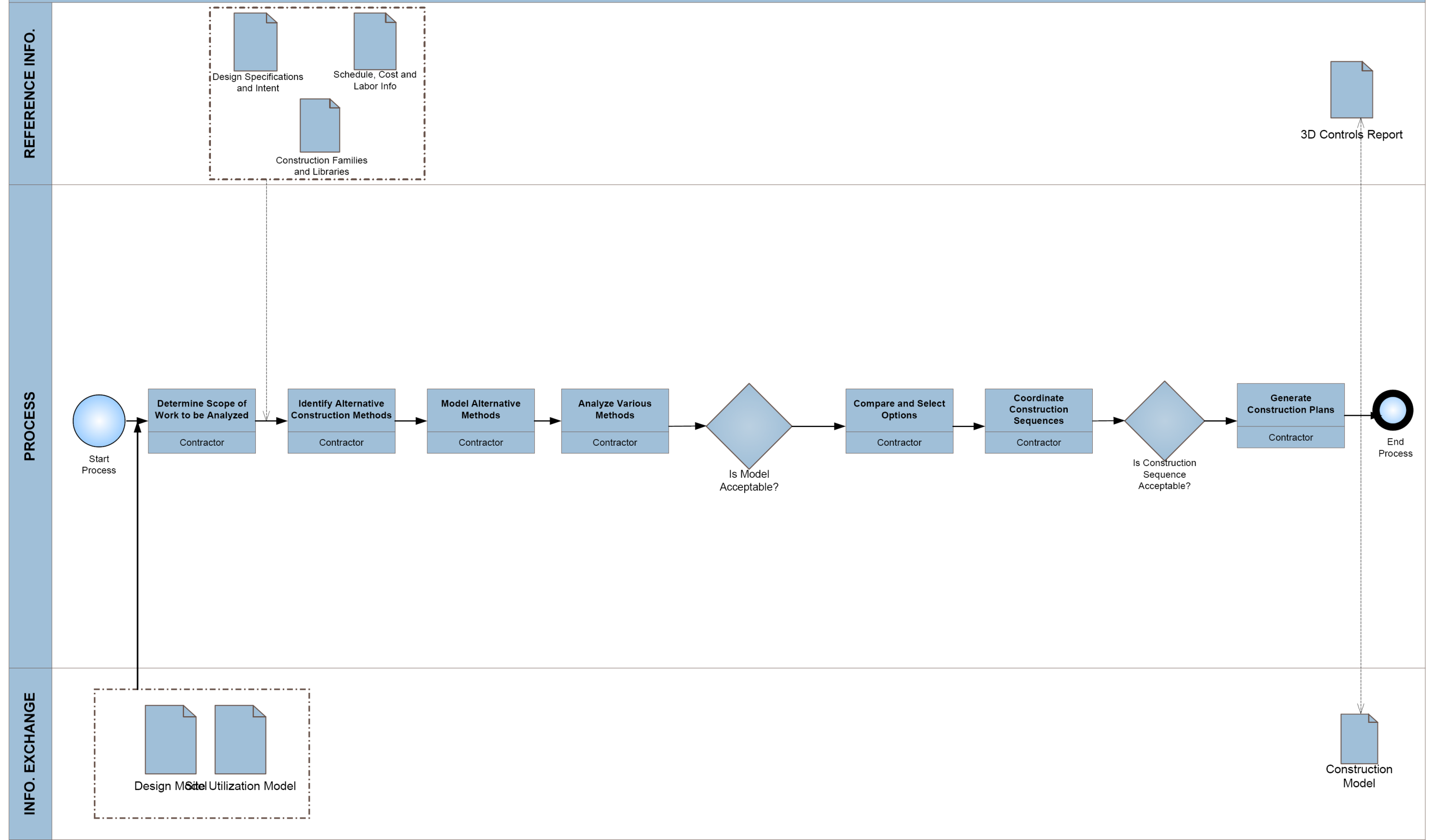

D

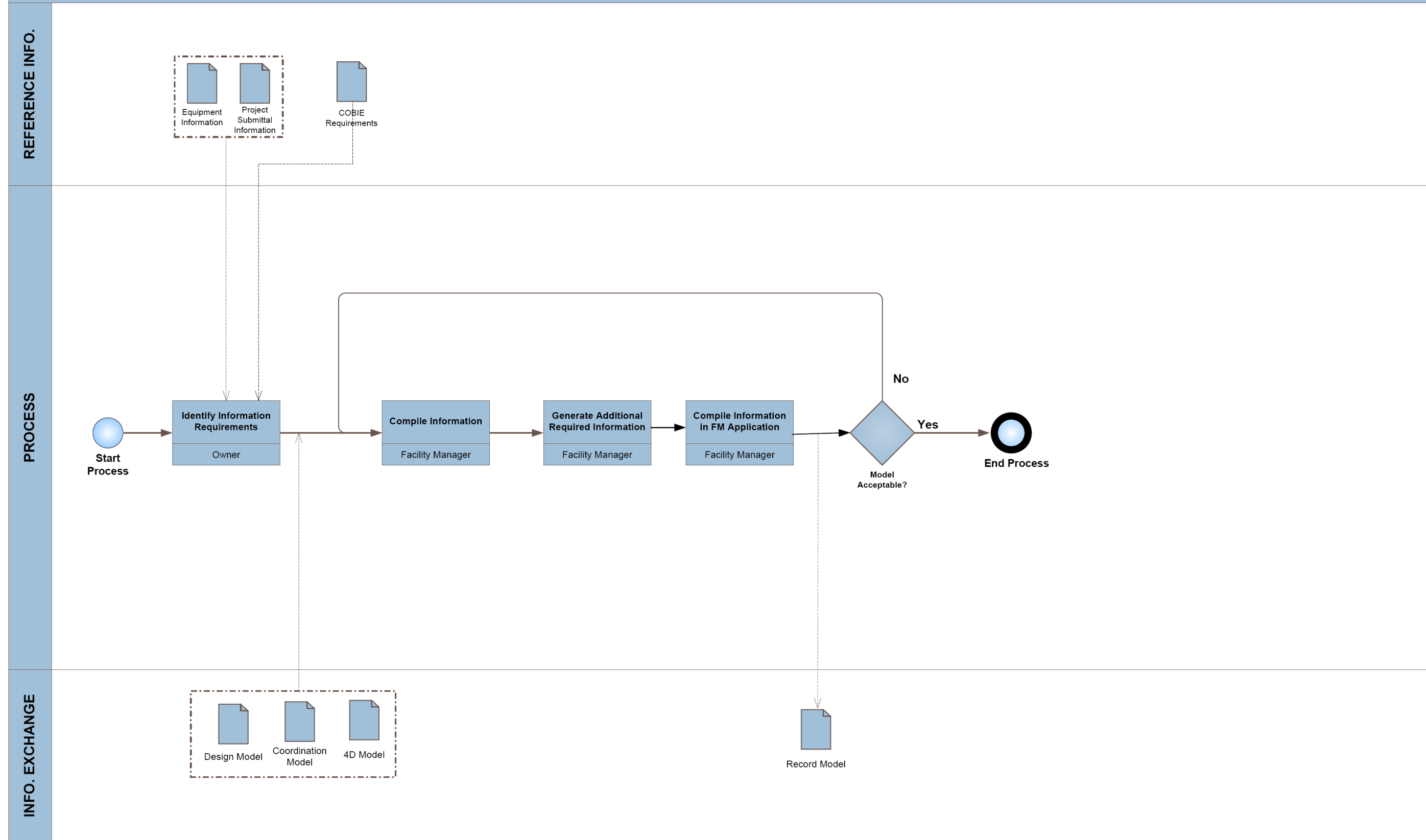

D

REFERENCE INFO.



PROCESS

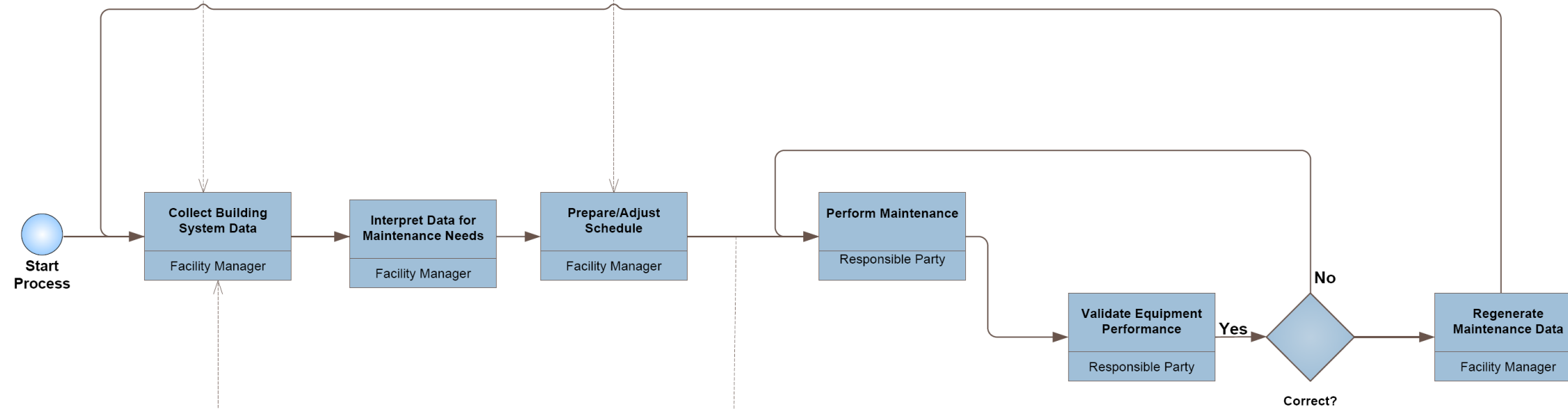

INFO. EXCHANGE



D

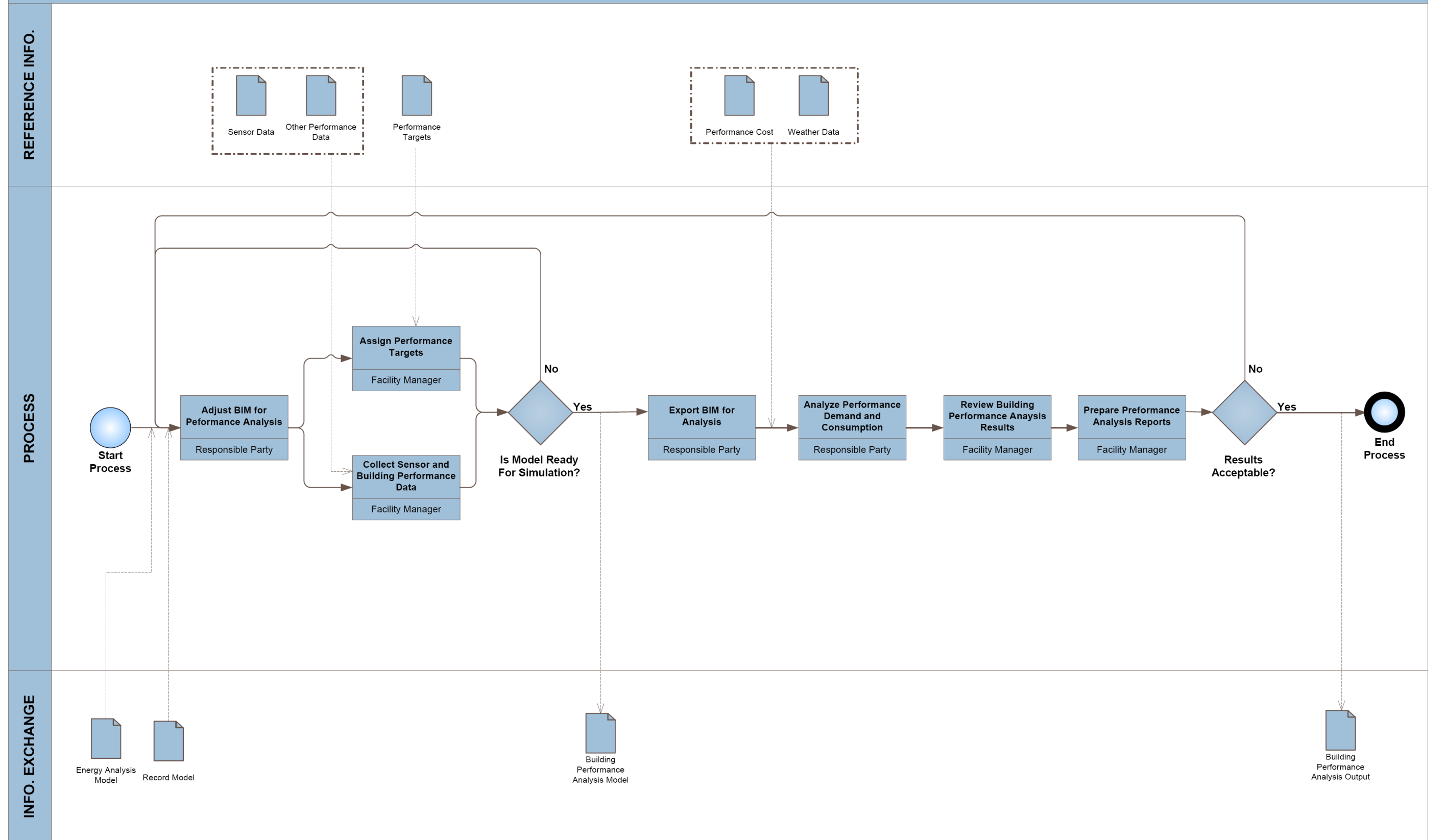

D

APPENDIX E – LAB EXAMPLE PROCESS MAPS

This appendix contains the following Laboratory Example BIM Process Maps:

Level 1: BIM Overview Map

Level 2: Detailed BIM Use Process Maps:

1. Design Authoring
2. 3D Design Coordination
3. Energy Analysis
4. 4D Modeling
5. Record Modeling

E

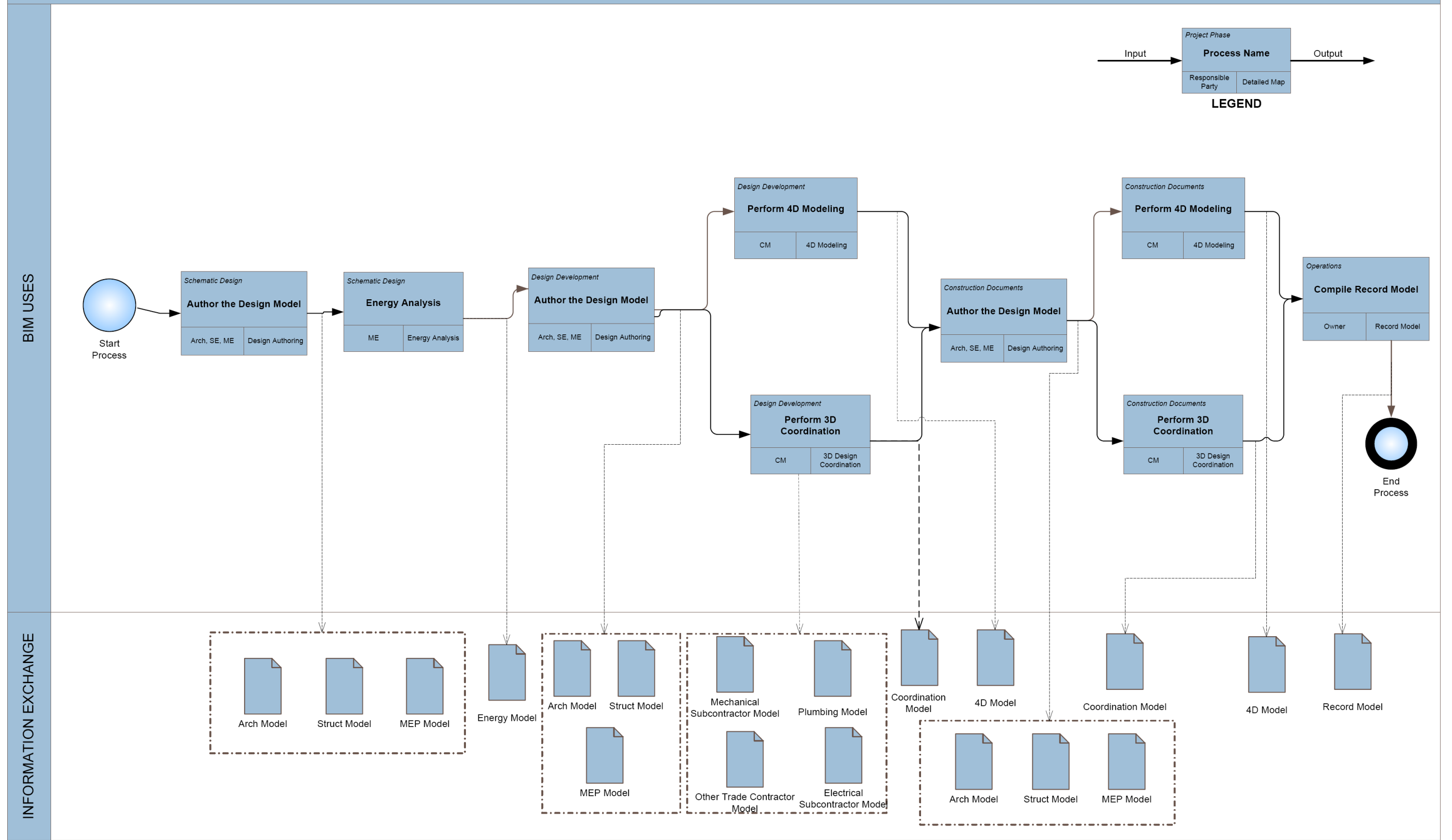

E

REFERENCE
INFORMATION

PROCESS

INFO. EXCHANGE

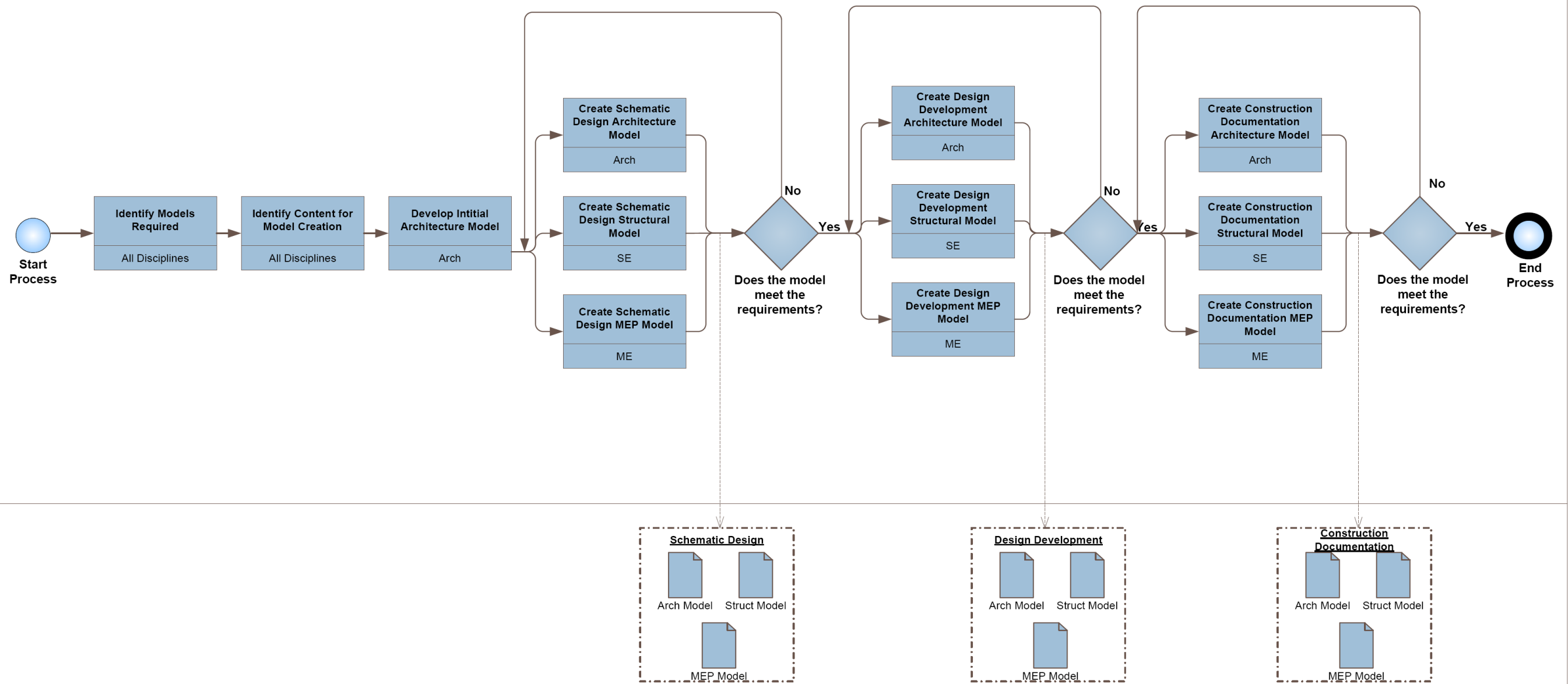

E

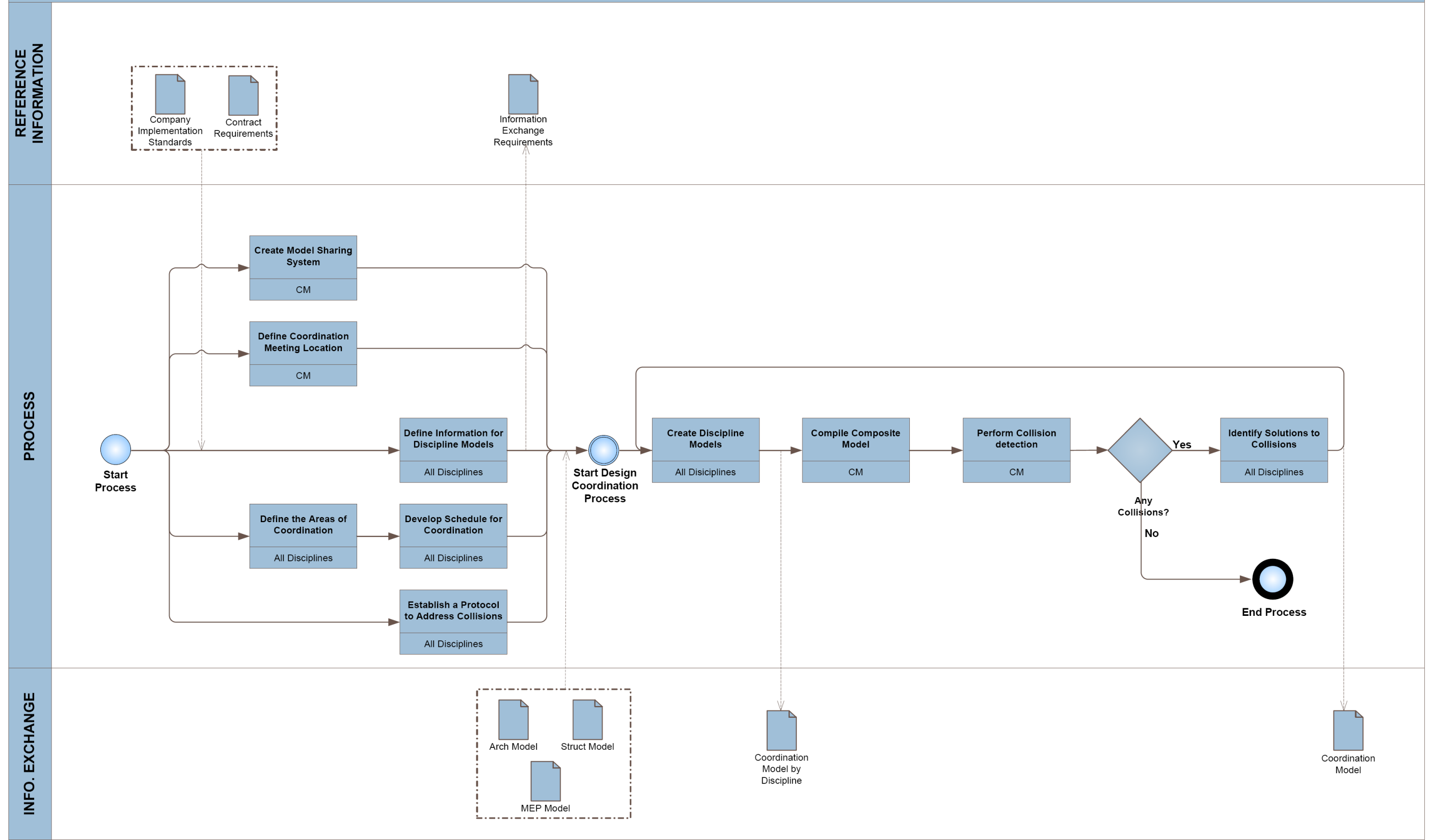

E

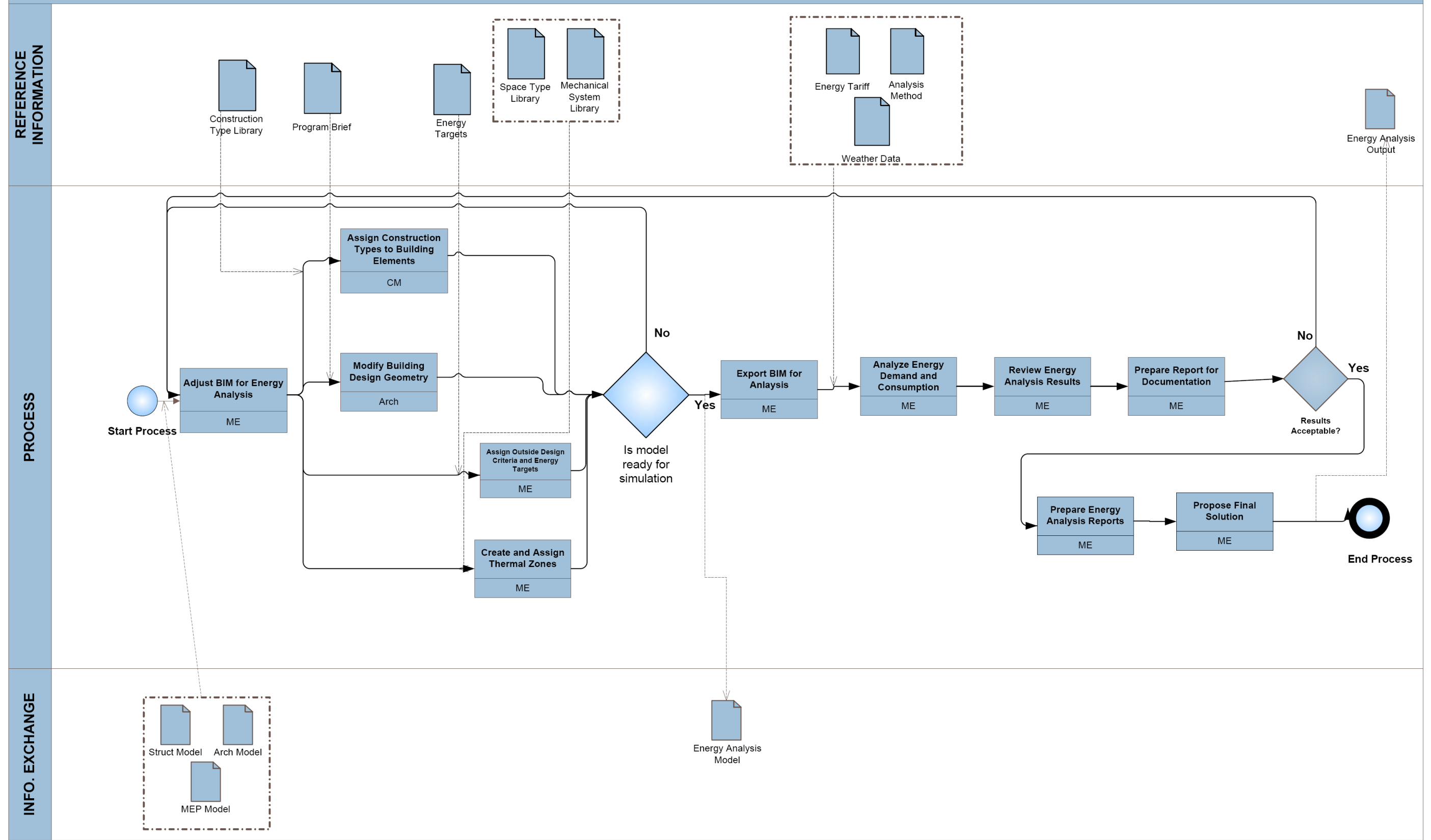

E

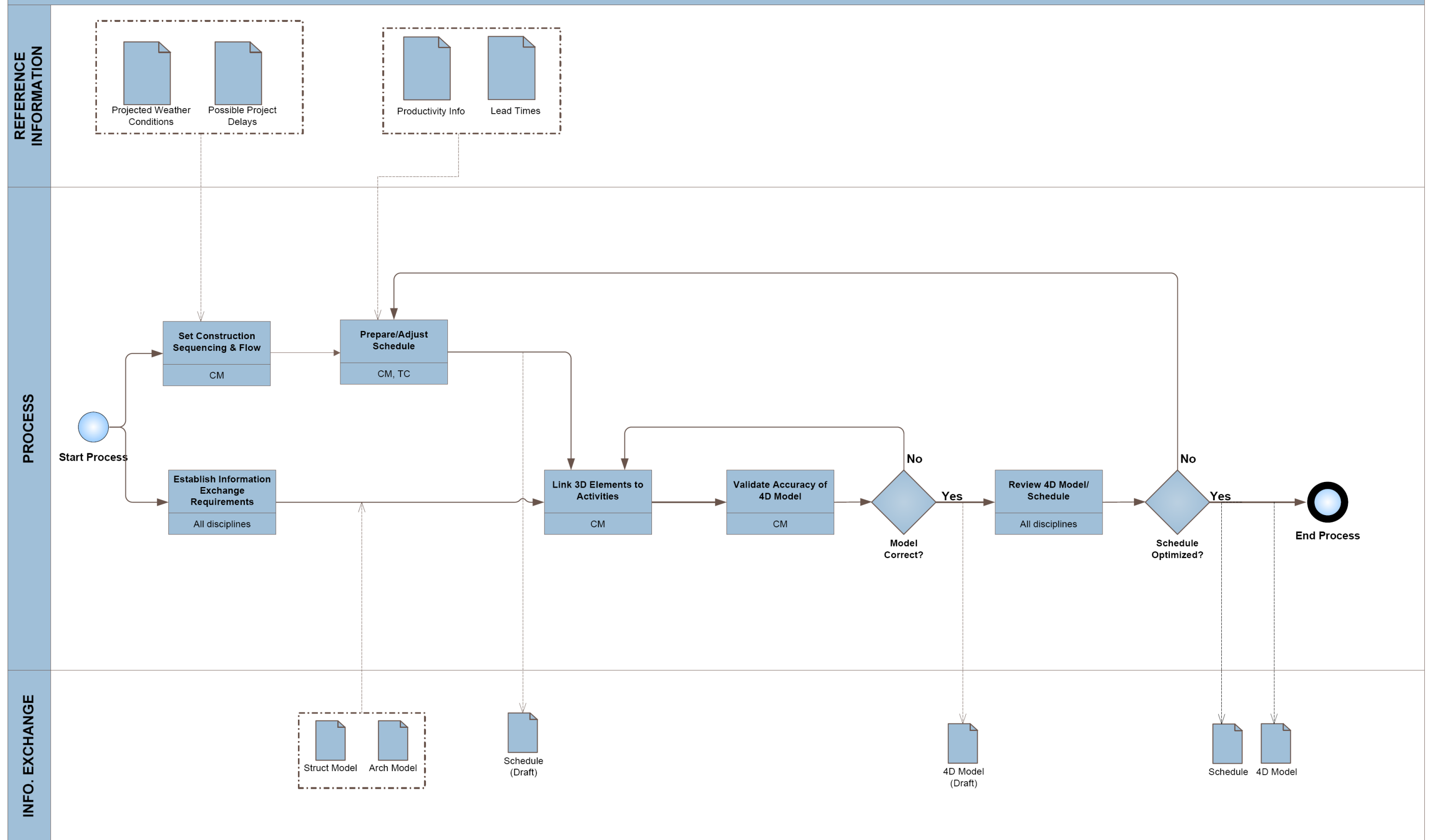

E

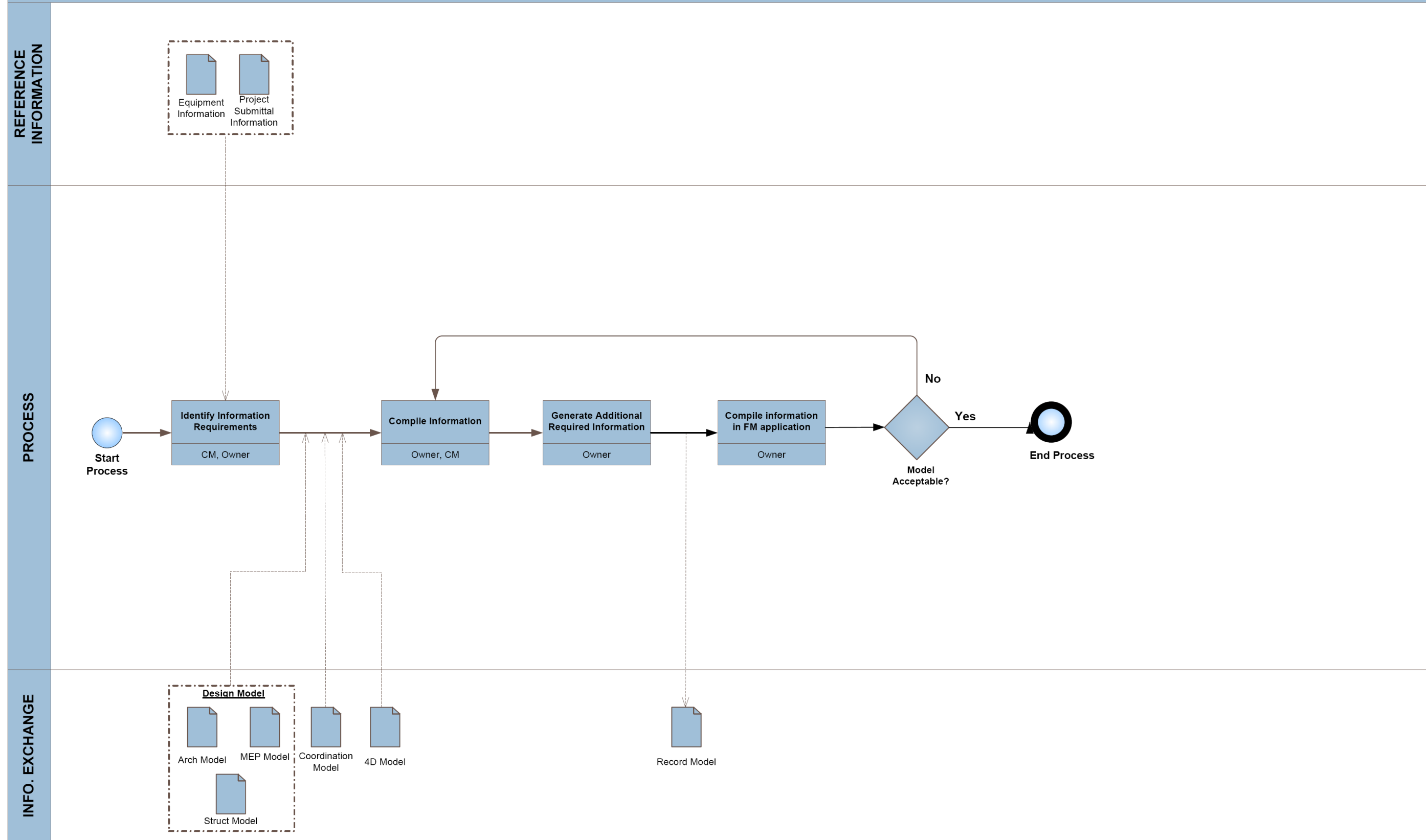

E

APPENDIX F – INFORMATION EXCHANGE WORKSHEET

Information		Responsible Party	
A	Accurate Size & Location, include materials and object parameters	A	Architect
B	General Size & Location, include parameter data	C	Contractor
		CV	Civil Engineer
C	Schematic Size & Location	FM	Facility Manager
		MEP	MEP Engineer
		SE	Structural Engineer
		TC	Trade Contractors

Information Exchange Title										
Time of Exchange (SD, DD, CD, Construction)										
Model Receiver										
Receiver File Format										
Application & Version										
Model Element Breakdown		Info	Resp Party	Notes	Info	Resp Party	Notes	Info	Resp Party	Notes
A	SUBSTRUCTURE									
	Foundations									
	Standard Foundations									
	Special Foundations									
	Slab on Grade									
	Basement Construction									
	Basement Excavation									
	Basement Walls									
B	SHELL									
	Superstructure									
	Floor Construction									
	Roof Construction									
	Exterior Enclosure									
	Exterior Walls									
	Exterior Windows									
	Exterior Doors									
	Roofing									
	Roof Coverings									
	Roof Openings									
C	INTERIORS									
	Interior Construction									
	Partitions									
	Interior Doors									
	Fittings									
	Stairs									
	Stair Construction									
	Stair Finishes									
	Interior Finishes									
	Wall Finishes									
	Floor Finishes									
	Ceiling Finishes									
D	SERVICES									
	Conveying Systems									
	Elevators & Lifts									
	Escalators & Moving Walks									
	Other Conveying Systems									
	Plumbing									
	Plumbing Fixtures									
	Domestic Water Distribution									
	Sanitary Waste									
	Rain Water Drainage									
	Other Plumbing Systems									
	HVAC									
	Energy Supply									
	Heat Generating Systems									
	Cooling Generating Systems									
	Distribution Systems									
	Terminal & Package Units									
	Systems Testing & Balancing									
	Other HVAC Systems & Equipment									



Fire Protection							
	Sprinklers						
	Standpipes						
	Fire Protection Specialties						
	Other Fire Protection Systems						
Electrical							
	Electrical Service & Distribution						
	Lighting and Branch Wiring						
	Communications & Security						
	Other Electrical Systems						
E	EQUIPMENT & FURNISHINGS						
	Equipment						
	Commercial Equipment						
	Institutional Equipment						
	Vehicular Equipment						
	Other Equipment						
	Furnishings						
	Fixed Furnishings						
F	SPECIAL CONSTRUCTION & DEMOLITION						
	Special Construction						
	Special Structures						
	Integrated Construction						
	Special Construction Systems						
	Special Facilities						
	Special Controls & Instrumentation						
	Selective Bldg Demo						
	Building Elements Demolition						
	Hazardous Components Abatement						
G	BUILDING SITework						
	Site Preparation						
	Site Clearing						
	Site Demolition & Relocations						
	Site Earthwork						
	Hazardous Waste Remediation						
	Site Improvements						
	Roadways						
	Parking Lots						
	Pedestrian Paving						
	Site Development						
	Landscaping						
	Site Civil/Mech Utilities						
	Water Supply & Distribution Systems						
	Sanitary Sewer Systems						
	Storm Sewer Systems						
	Heating Distribution						
	Cooling Distribution						
	Fuel Distribution						
	Other Civil/Mechanical Utilities						
	Site Electrical Utilities						
	Electrical Distribution						
	Site Lighting						
	Site Communications & Security						
	Other Electrical Utilities						
	Other Site Construction						
	Service Tunnels						
	Other Site Systems & Equipment						
1	Construction Systems						
	Construction Equipment						
	Temporary Safety						
	Temporary Security						
	Temporary Facilities						
	Weather Protection						
2	Space						
	Construction Activity Space						
	Analysis Space						
3	Information						
	Construction Information						
	Engineering Information						
	Record Information						

F

Building Information Modeling Execution Planning Guide

APPENDIX G – BIM PROJECT EXECUTION PLAN TEMPLATE

BIM PROJECT EXECUTION PLAN VERSION 2.0

FOR

[PROJECT TITLE]

DEVELOPED BY

[AUTHOR COMPANY]

This template is a tool that is provided to assist in the development of a BIM project execution plan as required per contract. The template plan was created from the buildingSMART alliance™ (bSa) Project “BIM Project Execution Planning” as developed by The Computer Integrated Construction (CIC) Research Group of The Pennsylvania State University. The bSa project is sponsored by The Charles Pankow Foundation (<http://www.pankowfoundation.org>), Construction Industry Institute (CII) (<http://www.construction-institute.org>), Penn State Office of Physical Plant (OPP) (<http://www.opp.psu.edu>), and The Partnership for Achieving Construction Excellence (PACE) (<http://www.engr.psu.edu/pace>). The BIM Project Execution Planning Guide can be downloaded at <http://www.engr.psu.edu/BIM/PxP>.

This coversheet can be replaced by a company specific coversheet that includes at a minimum document title, project title, project location, author company, and project number.

This work is licensed under the Creative Commons Attribution-Share Alike 3.0 United States License. To view a copy of this license, visit <http://creativecommons.org/licenses/by-sa/3.0/us/> or send a letter to Creative Commons, 171 Second Street, Suite 300, San Francisco, California, 94105, USA.



CHARLES PANKOW
FOUNDATION

Building Innovation through Research



Construction
Industry
Institute®

PENNSTATE



Office of
Physical Plant



G

BIM PROJECT EXECUTION PLAN
VERSION 2.0
FOR
[PROJECT TITLE]
DEVELOPED BY
[AUTHOR COMPANY]

TABLE OF CONTENTS

SECTION A: BIM PROJECT EXECUTION PLAN OVERVIEW	103
SECTION B: PROJECT INFORMATION	104
SECTION C: KEY PROJECT CONTACTS	105
SECTION D: PROJECT GOALS / BIM USES	106
SECTION E: ORGANIZATIONAL ROLES / STAFFING	107
SECTION F: BIM PROCESS DESIGN.....	108
SECTION G: BIM INFORMATION EXCHANGES	109
SECTION H: BIM AND FACILITY DATA REQUIREMENTS	110
SECTION I: COLLABORATION PROCEDURES	111
SECTION J: QUALITY CONTROL	113
SECTION K: TECHNOLOGICAL INFRASTRUCTURE NEEDS.....	114
SECTION L: MODEL STRUCTURE	115
SECTION M: PROJECT DELIVERABLES	116
SECTION N: DELIVERY STRATEGY / CONTRACT	117
SECTION O: ATTACHMENTS.....	118

SECTION A: BIM PROJECT EXECUTION PLAN OVERVIEW

To successfully implement Building Information Modeling (BIM) on a project, the project team has developed this detailed BIM Project Execution Plan. The BIM Project Execution Plan defines uses for BIM on the project (e.g. design authoring, cost estimating, and design coordination), along with a detailed design of the process for executing BIM throughout the project lifecycle.

[INSERT ADDITIONAL INFORMATION HERE IF APPLICABLE. FOR EXAMPLE: BIM MISSION STATEMENT This is the location to provide additional BIM overview information. Additional detailed information can be included as an attachment to this document.

Please note: Instructions and examples to assist with the completion of this guide are currently in grey. The text can and should be modified to suit the needs of the organization filling out the template. If modified, the format of the text should be changed to match the rest of the document. This can be completed, in most cases, by selecting the normal style in the template styles.

SAMPLE

SECTION B: PROJECT INFORMATION

This section defines basic project reference information and determined project milestones.

1. **PROJECT OWNER:**
2. **PROJECT NAME:**
3. **PROJECT LOCATION AND ADDRESS:**
4. **CONTRACT TYPE / DELIVERY METHOD:**
5. **BRIEF PROJECT DESCRIPTION:** [NUMBER OF FACILITIES, GENERAL SIZE, ETC]
6. **Additional Project Information:** [UNIQUE BIM PROJECT CHARACTERISTICS AND REQUIREMENTS]
7. **PROJECT NUMBERS:**

PROJECT INFORMATION	NUMBER
CONTRACT NUMBER:	
TASK ORDER:	
PROJECT NUMBER:	

8. PROJECT SCHEDULE / PHASES / MILESTONES:

Include BIM milestones, pre-design activities, major design reviews, stakeholder reviews, and any other major events which occur during the project lifecycle.

PROJECT PHASE / MILESTONE	ESTIMATED START DATE	ESTIMATED COMPLETION DATE	PROJECT STAKEHOLDERS INVOLVED
PRELIMINARY PLANNING			
DESIGN DOCUMENTS			
CONSTRUCTION DOCUMENTS			
CONSTRUCTION			

SECTION C: KEY PROJECT CONTACTS

List of lead BIM contacts for each organization on the project. Additional contacts can be included later in the document.

ROLE	ORGANIZATION	CONTACT NAME	LOCATION	E-MAIL	PHONE
Project Manager(s)					
BIM Manager(s)					
Discipline Leads					
Other Project Roles					

SAMPLE

SECTION D: PROJECT GOALS / BIM USES

Describe how the BIM Model and Facility Data are leveraged to maximize project value (e.g. design alternatives, life-cycle analysis, scheduling, estimating, material selection, pre-fabrication opportunities, site placement, etc.) Reference www.engr.psu.edu/bim/download for BIM Goal & Use Analysis Worksheet.

1. MAJOR BIM GOALS / OBJECTIVES:

State Major BIM Goals and Objectives

PRIORITY (HIGH/ MED/ LOW)	GOAL DESCRIPTION	POTENTIAL BIM USES

2. BIM USE ANALYSIS WORKSHEET: ATTACHMENT 1

Reference www.engr.psu.edu/bim/download for BIM Goal & Use Analysis Worksheet. Attach BIM Use analysis Worksheet as Attachment 1.

3. BIM USES:

Highlight and place an X next to the additional BIM Uses as selected by the project team using the BIM Goal & Use Analysis Worksheet. See BIM Project Execution Planning Guide at www.engr.psu.edu/BIM/BIM_Uses for Use descriptions. Include additional BIM Uses as applicable in empty cells.

X	PLAN	X	DESIGN	X	CONSTRUCT	X	OPERATE
	PROGRAMMING		DESIGN AUTHORING		SITE UTILIZATION PLANNING		BUILDING MAINTENANCE SCHEDULING
	SITE ANALYSIS		DESIGN REVIEWS		CONSTRUCTION SYSTEM DESIGN		BUILDING SYSTEM ANALYSIS
			3D COORDINATION		3D COORDINATION		ASSET MANAGEMENT
			STRUCTURAL ANALYSIS		DIGITAL FABRICATION		SPACE MANAGEMENT / TRACKING
			LIGHTING ANALYSIS		3D CONTROL AND PLANNING		DISASTER PLANNING
			ENERGY ANALYSIS		RECORD MODELING		RECORD MODELING
			MECHANICAL ANALYSIS				
			OTHER ENG. ANALYSIS				
			SUSTAINABILITY (LEED) EVALUATION				
			CODE VALIDATION				
	PHASE PLANNING (4D MODELING)		PHASE PLANNING (4D MODELING)		PHASE PLANNING (4D MODELING)		PHASE PLANNING (4D MODELING)
	COST ESTIMATION		COST ESTIMATION		COST ESTIMATION		COST ESTIMATION
	EXISTING CONDITIONS MODELING		EXISTING CONDITIONS MODELING		EXISTING CONDITIONS MODELING		EXISTING CONDITIONS MODELING

SECTION E: ORGANIZATIONAL ROLES / STAFFING

Determine the project's BIM Roles and Responsibilities and BIM Use Staffing.

1. BIM ROLES AND RESPONSIBILITIES:

Describe BIM roles and responsibilities such as BIM Managers, Project Manager, Draftspersons, etc.

2. BIM USE STAFFING:

For each BIM Use selected, identify the team within the organization (or organizations) who will staff and perform that Use and estimate the personal time required.

BIM USE	ORGANIZATION	NUMBER OF TOTAL STAFF FOR BIM USE	ESTIMATED WORKER HOURS	LOCATION(S)	LEAD CONTACT
3D coordination	Contractor A				
	B				
	C				

SECTION F: BIM PROCESS DESIGN

Provide process maps for each BIM Use selected in section D: Project Goals/BIM Objectives. These process maps provide a detailed plan for execution of each BIM Use. They also define the specific Information Exchanges for each activity, building the foundation for the entire execution plan. The plan includes the Overview Map (Level 1) of the BIM Uses, a Detailed Map of each BIM Use (Level 2), and a description of elements on each map, as appropriate. Level 1 and 2 sample maps are available for download at www.engr.psu.edu/BIM/download. (Please note that these are sample maps and should be modified based on project specific information and requirements). Please reference Chapter Three: Designing BIM Project Execution Process in the BIM Project Execution Planning Guide found at www.engr.psu.edu/BIM/PxP

1. LEVEL ONE PROCESS OVERVIEW MAP: ATTACHMENT 2

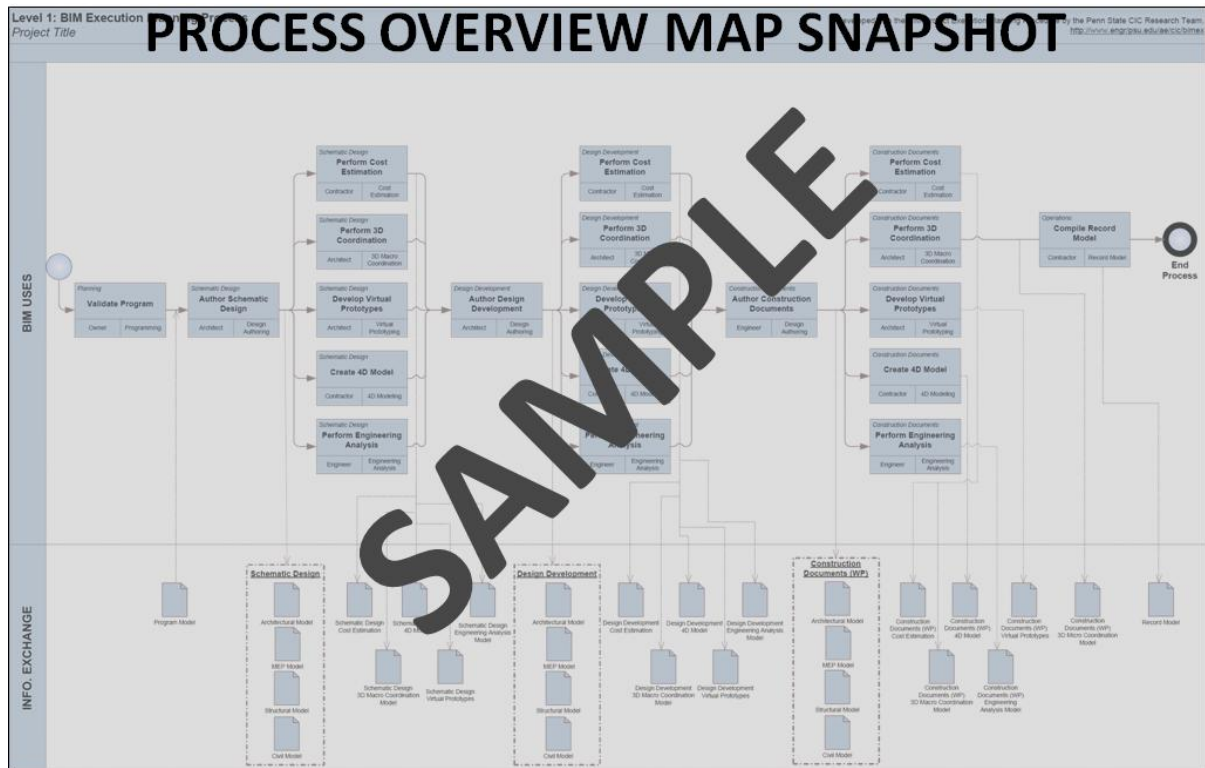

2. LIST OF LEVEL TWO – DETAILED BIM USE PROCESS MAP(S): ATTACHMENT 3

The following are examples. Modify for specific project. Some Process Maps may need to be removed, while some process maps may need to be added.

- a. Existing Conditions Modeling
- b. Cost Estimation
- c. 4D Modeling
- d. Programming
- e. Site Analysis
- f. Design Reviews
- g. Design Authoring
- h. Energy Analysis
- i. Structural Analysis
- j. Lighting Analysis
- k. 3D Coordination
- l. Site Utilization Planning
- m. 3D Control and Planning
- n. Record Modeling
- o. Maintenance Scheduling
- p. Building System Analysis

[Delete unused or add additional process maps from list]

SECTION G: BIM INFORMATION EXCHANGES

Model elements by discipline, level of detail, and any specific attributes important to the project are documented using information exchange worksheet. See Chapter Four: Defining the Requirements for Information Exchanges in the BIM Project Execution Planning Guide for details on completing this template.

1. LIST OF INFORMATION EXCHANGE WORKSHEET(S): ATTACHMENT 4

The following are examples. Modify for specific project. Some Information Exchanges may need to be removed, while some Information Exchanges may need to be added.

- a. Existing Conditions Modeling
- b. Cost Estimation
- c. 4D Modeling
- d. Programming
- e. Site Analysis
- f. Design Reviews
- g. Design Authoring
- h. Energy Analysis
- i. Structural Analysis
- j. Lighting Analysis
- k. 3D Coordination
- l. Site Utilization Planning
- m. 3D Control and Planning
- n. Record Modeling
- o. Maintenance Scheduling
- p. Building System Analysis
- q. [Delete unused information exchanges from list]

INFORMATION EXCHANGE (IE)		Programming		Design Authoring		Existing Conditions Modeling		Cost Estimation		3D Coordination		Design Reviews	
Information		Info	Resp Party	Info	Resp Party	Info	Resp Party	Info	Resp Party	Info	Resp Party	Info	Resp Party
BIM Use Title		Planning		Design		Modeling		Design		Design		Design Reviews	
Project Phase		Planning		Design		Modeling		Design		Design		Design Reviews	
Type of Exchange (SD, DD, CD, Construction)		Planning		Design		Modeling		Design		Design		Design Reviews	
Responsible Party (Information Provider)		Planning		Design		Modeling		Design		Design		Design Reviews	
Responsible Party (Information Receiver)		Planning		Design		Modeling		Design		Design		Design Reviews	
Application & Version		Planning		Design		Modeling		Design		Design		Design Reviews	
Model Element Breakdown		Planning		Design		Modeling		Design		Design		Design Reviews	
A SUBSTRUCTURE		Planning		Design		Modeling		Design		Design		Design Reviews	
Foundations		Planning		Design		Modeling		Design		Design		Design Reviews	
Standard Foundations		Planning		Design		Modeling		Design		Design		Design Reviews	
Special Foundations		Planning		Design		Modeling		Design		Design		Design Reviews	
Foundation		Planning		Design		Modeling		Design		Design		Design Reviews	
Basement Construction		Planning		Design		Modeling		Design		Design		Design Reviews	
Basement Enclosure		Planning		Design		Modeling		Design		Design		Design Reviews	
Basement Walls		Planning		Design		Modeling		Design		Design		Design Reviews	
B SHELL		Planning		Design		Modeling		Design		Design		Design Reviews	
Superstructure		Planning		Design		Modeling		Design		Design		Design Reviews	
Floor Construction		Planning		Design		Modeling		Design		Design		Design Reviews	
Roof Construction		Planning		Design		Modeling		Design		Design		Design Reviews	
Exterior Enclosure		Planning		Design		Modeling		Design		Design		Design Reviews	
Exterior Walls		Planning		Design		Modeling		Design		Design		Design Reviews	
Exterior Windows		Planning		Design		Modeling		Design		Design		Design Reviews	
Exterior Doors		Planning		Design		Modeling		Design		Design		Design Reviews	
Roofing		Planning		Design		Modeling		Design		Design		Design Reviews	
Roof Coverings		Planning		Design		Modeling		Design		Design		Design Reviews	
Roof Openings		Planning		Design		Modeling		Design		Design		Design Reviews	
C INTERIORS		Planning		Design		Modeling		Design		Design		Design Reviews	
Interior Construction		Planning		Design		Modeling		Design		Design		Design Reviews	
Partitions		Planning		Design		Modeling		Design		Design		Design Reviews	
Interior Doors		Planning		Design		Modeling		Design		Design		Design Reviews	
Partitions		Planning		Design		Modeling		Design		Design		Design Reviews	
Stairs		Planning		Design		Modeling		Design		Design		Design Reviews	
Stair Construction		Planning		Design		Modeling		Design		Design		Design Reviews	
Stair Finishes		Planning		Design		Modeling		Design		Design		Design Reviews	
Interior Finishes		Planning		Design		Modeling		Design		Design		Design Reviews	
Wall Finishes		Planning		Design		Modeling		Design		Design		Design Reviews	
Floor Finishes		Planning		Design		Modeling		Design		Design		Design Reviews	
Ceiling Finishes		Planning		Design		Modeling		Design		Design		Design Reviews	
D SERVICES		Planning		Design		Modeling		Design		Design		Design Reviews	
Conveying Systems		Planning		Design		Modeling		Design		Design		Design Reviews	
Elevators & Lifts		Planning		Design		Modeling		Design		Design		Design Reviews	
Escalators & Moving Walks		Planning		Design		Modeling		Design		Design		Design Reviews	
Mechanical Systems		Planning		Design		Modeling		Design		Design		Design Reviews	

2. MODEL DEFINITION WORKSHEET: ATTACHMENT 5

(Attach Model Definition Worksheet)

MODEL DEFINITION (MOD)		Planning		Design		Construction		Operations	
Information		Info	Resp Party	Info	Resp Party	Info	Resp Party	Info	Resp Party
Project Phase Deliverable		Planning		Design		Construction		Operations	
Author File Format (if varies, specify in notes)		Planning		Design		Construction		Operations	
Application & Version		Planning		Design		Construction		Operations	
Model Element Breakdown		Planning		Design		Construction		Operations	
A SUBSTRUCTURE		Planning		Design		Construction		Operations	
Foundations		Planning		Design		Construction		Operations	
Standard Foundations		Planning		Design		Construction		Operations	
Special Foundations		Planning		Design		Construction		Operations	
Foundation		Planning		Design		Construction		Operations	
Basement Construction		Planning		Design		Construction		Operations	
Basement Enclosure		Planning		Design		Construction		Operations	
Basement Walls		Planning		Design		Construction		Operations	
B SHELL		Planning		Design		Construction		Operations	
Superstructure		Planning		Design		Construction		Operations	
Floor Construction		Planning		Design		Construction		Operations	
Green Roof		Planning		Design		Construction		Operations	
Interior Columns		Planning		Design		Construction		Operations	
Beams		Planning		Design		Construction		Operations	
Trusses		Planning		Design		Construction		Operations	
Exterior Enclosure		Planning		Design		Construction		Operations	
Exterior Walls		Planning		Design		Construction		Operations	
Curtain Wall System		Planning		Design		Construction		Operations	
Exterior Windows - Glass Panels		Planning		Design		Construction		Operations	
Exterior Windows - Glass Panels		Planning		Design		Construction		Operations	
Exterior Doors		Planning		Design		Construction		Operations	
Roofing		Planning		Design		Construction		Operations	
Roof Coverings		Planning		Design		Construction		Operations	
Roof Openings		Planning		Design		Construction		Operations	
C INTERIORS		Planning		Design		Construction		Operations	
Interior Construction		Planning		Design		Construction		Operations	
Partitions		Planning		Design		Construction		Operations	
Interior Doors		Planning		Design		Construction		Operations	
Partitions		Planning		Design		Construction		Operations	
Stairs		Planning		Design		Construction		Operations	
Stair Construction		Planning		Design		Construction		Operations	
Stair Finishes		Planning		Design		Construction		Operations	
Interior Finishes		Planning		Design		Construction		Operations	
Wall Finishes		Planning		Design		Construction		Operations	
Floor Finishes		Planning		Design		Construction		Operations	
Ceiling Finishes		Planning		Design		Construction		Operations	
D SERVICES		Planning		Design		Construction		Operations	
Conveying Systems		Planning		Design		Construction		Operations	
Elevators & Lifts		Planning		Design		Construction		Operations	
Escalators & Moving Walks		Planning		Design		Construction		Operations	
Mechanical Systems		Planning		Design		Construction		Operations	



SECTION H: BIM AND FACILITY DATA REQUIREMENTS

The section should include the owners BIM requirements. It is important that the owner's requirements for BIM be considered so that they can be incorporated into the project's BIM process.

SECTION I: COLLABORATION PROCEDURES

1. COLLABORATION STRATEGY:

Describe how the project team will collaborate. Include items such as communication methods, document management and transfer, and record storage, etc.

2. MEETING PROCEDURES:

The following are examples of meetings that should be considered.

MEETING TYPE	PROJECT STAGE	FREQUENCY	PARTICIPANTS	LOCATION
BIM REQUIREMENTS KICK-OFF				
BIM EXECUTION PLAN DEMONSTRATION				
DESIGN COORDINATION				
CONSTRUCTION OVER-THE-SHOULDER PROGRESS REVIEWS				
ANY OTHER BIM MEETINGS THAT OCCURS WITH MULTIPLE PARTIES				

3. MODEL DELIVERY SCHEDULE OF INFORMATION EXCHANGE FOR SUBMISSION AND APPROVAL:

Document the information exchanges and file transfers that will occur on the project.

INFORMATION EXCHANGE	FILE SENDER	FILE RECEIVER	ONE-TIME or FREQUENCY	DUE DATE or START DATE	MODEL FILE	MODEL SOFTWARE	NATIVE FILE TYPE	FILE EXCHANGE TYPE
DESIGN AUTHORIZING TO 3D COORDINATION	STRUCTURAL ENGINEER	(FTP POST) (COORDINATION LEAD)	WEEKLY	[DATE]	STRUCT	DESIGN APP	.XYZ	.XYZ .ABC
	MECHANICAL ENGINEER	(FTP POST) (COORDINATION LEAD)	WEEKLY	[DATE]	MECH	DESIGN APP	.XYZ	.XYZ .ABC

4. INTERACTIVE WORKSPACE

The project team should consider the physical environment it will need throughout the lifecycle of the project to accommodate the necessary collaboration, communication, and reviews that will improve the BIM Plan decision making process. Describe how the project team will be located. Consider questions like “will the team be collocated?” If so, where is the location and what will be in that space? Will there be a BIM Trailer? If yes, where will it be located and what will be in the space such as computers, projectors, tables, table configuration? Include any additional information necessary information about workspaces on the project.

5. ELECTRONIC COMMUNICATION PROCEDURES:

(Note: File Naming and Folder Structure will be discussed in Section L: Model Structure).

The following document management issues should be resolved and a procedure should be defined for each: Permissions / access, File Locations, FTP Site Location(s), File Transfer Protocol, File / Folder Maintenance, etc.

FILE LOCATION	FILE STRUCTURE / NAME	FILE TYPE	PASSWORD PROTECT	FILE MAINTAINER	UPDATED
FTP SITE: ftp://ftp.****.com/***/****	ROOT PROJECT FOLDER	FOLDER	YES *****	JIM McBIM	ONCE
	ARCH ROOT FOLDER	FOLDER			ONCE
	ARCH-11111-BL001.xyz	.xyz			DAILY
NETWORK drive @ PSU F:\PROJECT\BIM	ROOT PROJECT FOLDER	FOLDER	NO	JIM McBIM	ONCE
Project Management Software www.*****.com					

SECTION J: QUALITY CONTROL

1. OVERALL STRATEGY FOR QUALITY CONTROL:

Describe the strategy to control the quality of the model.

2. QUALITY CONTROL CHECKS:

The following checks should be performed to assure quality.

CHECKS	DEFINITION	RESPONSIBLE PARTY	SOFTWARE PROGRAM(S)	FREQUENCY
VISUAL CHECK	Ensure there are no unintended model components and the design intent has been followed			
INTERFERENCE CHECK	Detect problems in the model where two building components are clashing including soft and hard			
STANDARDS CHECK	Ensure that the BIM and AEC CADD Standard have been followed (fonts, dimensions, line styles, levels/layers, etc)			
MODEL INTEGRITY CHECKS	Describe the QC validation process used to ensure that the Project Facility Data set has no undefined, incorrectly defined or duplicated elements and the reporting process on non-compliant elements and corrective action plans			

3. MODEL ACCURACY AND TOLERANCES:

Models should include all appropriate dimensioning as needed for design intent, analysis, and construction. Level of detail and included model elements are provided in the Information Exchange Worksheet.

PHASE	DISCIPLINE	TOLERANCE
DESIGN DOCUMENTS	ARCH	ACCURATE TO +/- [#] OF ACTUAL SIZE AND LOCATION
SHOP DRAWINGS	MECH CONTRACTOR	ACCURATE TO +/- [#] OF ACTUAL SIZE AND LOCATION

SECTION K: TECHNOLOGICAL INFRASTRUCTURE NEEDS

1. SOFTWARE:

List software used to deliver BIM. Remove software that is not applicable.

BIM USE	DISCIPLINE (if applicable)	SOFTWARE	VERSION
DESIGN AUTHORING	ARCH	XYZ DESIGN APPLICATION	VER. X.X (YEAR)

2. COMPUTERS / HARDWARE:

Understand hardware specification becomes valuable once information begins to be shared between several disciplines or organizations. It also becomes valuable to ensure that the downstream hardware is not less powerful than the hardware used to create the information. In order to ensure that this does not happen, choose the hardware that is in the highest demand and most appropriate for the majority of BIM Uses.

BIM USE	HARDWARE	OWNER OF HARDWARE	SPECIFICATIONS
DESIGN AUTHORING	XXX COMPUTER SYSTEM	ARCHITECT X	PROCESSOR, OPERATING SYSTEM, MEMORY STORAGE, GRAPHICS, NETWORK CARD, ETC.

3. MODELING CONTENT AND REFERENCE INFORMATION

Identify items such as families, workspaces, and databases.

BIM USE	DISCIPLINE (if applicable)	MODELING CONTENT / REFERENCE INFORMATION	VERSION
DESIGN AUTHORING	ARCH	XYZ APP FAMILIES	VER. X.X. (YEAR)
ESTIMATING	CONTRACTOR	PROPRIETARY DATABASE	VER. X.X (YEAR)

SECTION L: MODEL STRUCTURE

1. FILE NAMING STRUCTURE:

Determine and list the structure for model file names.

FILE NAMES FOR MODELS SHOULD BE FORMATTED AS:	
DISCIPLINE - PROJECT NUMBER – BUILDING NUMBER.XYZ (example: ARCH-11111-BL001.xyz)	
ARCHITECTURAL MODEL	ARCH-
CIVIL MODEL	CIVIL-
MECHANICAL MODEL	MECH-
PLUMBING MODEL	PLUMB-
ELECTRICAL MODEL	ELEC-
STRUCTURAL MODEL	STRUCT-
ENERGY MODEL	ENERGY-
CONSTRUCTION MODEL	CONST-
COORDINATION MODEL	COORD-

2. MODEL STRUCTURE:

Describe and diagram how the Model is separated, e.g., by building, by floors, by zones, by areas, and/or by disciplines.

3. MEASUREMENT AND COORDINATE SYSTEMS:

Describe the measurement system (Imperial or Metric) and coordinate system (geo-referenced) used.

4. BIM AND CAD STANDARDS:

Identify items such as the BIM and CAD standards, content reference information, and the version of IFC, etc.

STANDARD	VERSION	BIM USES APPLICABLE	ORGANIZATIONS APPLICABLE
CAD STANDARD		DESIGN AUTHORIZING	ARCHITECT
IFC	VERSION/MVD(s)	RECORD MODELING	CONSTRUCTION MANAGER

SECTION M: PROJECT DELIVERABLES

In this section, list the BIM deliverables for the project and the format in which the information will be delivered.

BIM SUBMITTAL ITEM	STAGE	APPROXIMATE DUE DATE	FORMAT	NOTES
	Design Development			
	Construction Documents			
	Construction			
Record Model	Close out		(.xyz)	See Record Model Information Exchange to ensure that the proper information is contained in this model

SECTION N: DELIVERY STRATEGY / CONTRACT

1. DELIVERY AND CONTRACTING STRATEGY FOR THE PROJECT:

What additional measures need to be taken to successfully use BIM with the selected delivery method and contract type?

2. TEAM SELECTION PROCEDURE:

How will you select future team members in regards to the above delivery strategy and contract type?

3. BIM CONTRACTING PROCEDURE:

How should BIM be written into the future contracts? (If documents / contracts are developed, please attach as attachment 6)

SAMPLE

SECTION O: ATTACHMENTS

1. **BIM USE SELECTION WORKSHEET** [FROM SECTION D]
2. **LEVEL 1 PROCESS OVERVIEW MAP** [FROM SECTION F]
3. **LEVEL 2 DETAILED BIM USE PROCESS MAP(S)** [FROM SECTION F]
4. **INFORMATION EXCHANGE REQUIREMENT WORKSHEET(S)** [FROM SECTION G]
5. **MODEL DEFINITION WORKSHEET** [FROM SECTION G]
6. **DEVELOPED DOCUMENTS / CONTRACTS** [FROM SECTION H]

APPENDIX H – BIM EXECUTION PLANNING CATEGORY GUIDE

BIM Execution Planning Guide	AIA BIM Protocol Ex.	Autodesk Comm. Spec.	Consensus Docs BIM Addendum	USACE BIM Roadmaps
Project Reference Information				
Project Overview Information		X		
BIM Contractual Requirements			X	
Key Project Contacts		X	X	X
Project Goals/BIM Objectives				
Purpose of BIM Implementation		X		X
Why Key BIM Use Decisions		X		X
BIM Process Design				
Process Maps for BIM Project Activities		X		
Define Information Exchanges		X		X
Delivery Strategy/Contract				
Definition of Delivery Structure		X	X	
Definition of Selection				
Definition of Contracting			X	
BIM Scope Definitions				
Model Elements by Discipline	X			
Level of Detail	X	X	X	X
Specific Model Attributes	X	X	X	X
Organizational Roles and Responsibilities				
Roles and Responsibilities of Each Organization	X	X		X
Define Contracting Strategies for Organizations			X	
Communication Procedures				
Electronic Communication Procedures		X		
Meeting Communication Procedure				
Technology Infrastructure Needs				
Hardware		X		X
Software		X	X	X
Space			X	
Networking Requirements		X		X
Model Quality Control Procedures				
Methods to ensure model accuracy	X	X	X	X
Glossary of Terms				
	X	X	X	X

APPENDIX I – BIBLIOGRAPHY

AIA. (2008). *Model Progression Specification for BIM*. Retrieved 4 20, 2009, from Integrated Project Delivery: <http://ipd-ca.net>

AutoDesk. (2008). *Autodesk Communication Specifications*. San Rafael, California: AutoDesk.

Fallon, K., & Palmer, M. (2007). *General Buildings Information Handover Guide: Principles, Methodology, and Case Studies*. Washington, D.C.: National Institute of Standards and Technology.

Larson, D., & Golden, K. (2008). *Entering the Brave New World: An Introduction to Contracting BIM*. 34.

Lowe, R., & Muncey, J. (2008). *The ConsensusDOCS 301 BIM Addendum*. Forum on the Construction Industry: American Bar Association.

National Institute of Building Sciences. (2007). *United States National Building Information Modeling Standard: Version 1-part 1 Overview, Principles, and Methodologies*. National Institute of Building Sciences.

Perlberg, B. (2009). *ConsensusDOCS: Contracts Built by Consensus for the Project's Best Interest*. 30 (1).

US Army Corps of Engineers. (2008). *BIM Road Map*. Retrieved March 17, 2008, from BIM Road Map: www.bimroadmap.com

APPENDIX J – GLOSSARY

BIM (Building Information Modeling) (CIC Research Program): a process focused on the development, use and transfer of a digital information model of a building project to improve the design, construction and operations of a project or portfolio of facilities.

BIM (Building Information Model) (NBIMS): a digital representation of physical and functional characteristics of a facility. A BIM is a shared knowledge resource for information about a facility forming a reliable basis for decisions during its life-cycle; defined as existing from earliest conception to demolition. A basic premise of BIM is collaboration by different stakeholders at different phases of the life cycle of a facility to insert, extract, update or modify information in the BIM to support and reflect the roles of that stakeholder.

BIM Deliverables: Information (in numerous formats) that may be required by contract or agreement to be submitted or passed to another party.

BIM Goals: Objectives used to define the potential value of BIM for a project and for project team members. BIM Goals help to define how and why BIM will be used on a project or in an organization.

BIM Process: A generic name for the practice of performing BIM. This process can be planned or unplanned. The BIM Process may also be referred to as the BIM Execution Process or the BIM Project Execution Process. The BIM Project Execution Planning Process suggests diagramming the BIM process using process maps.

BIM Process Maps: a diagram of how BIM will be applied on a project. The BIM Project Execution Plan proposes two levels of Process Maps: BIM Overview Map and Detailed BIM Use Process Maps.

BIM Project Execution Plan (BIM Plan): Is a planning the results from the BIM Project Execution Planning Process. This document lays out how BIM will be implemented on the project as a result of the decision of the group.

BIM Project Execution Planning Procedure: Is a process for planning the execution of BIM on a project. It consists of four primary steps: 1) identify BIM Goals and BIM Uses, 2) design BIM Project Execution Process, 3) develop Information Exchanges, 4) define supporting infrastructure for BIM Implementation.

BIM Use: A unique task or procedure on a project which can benefit from the application and integration of BIM into that process.

Detailed BIM Use Process Maps: A comprehensive BIM Process Map that defines the various sequences to perform a specific application of BIM or BIM Uses. These maps also identify the responsible parties for each process, reference information content, and the information exchanges which will be created and shared with other processes.

Information Exchange (IE): the information passed from one party to another in the BIM process. The parties involved should agree upon and understand what information will be exchanged. These are often in the form of deliverables from a process that will be required as a resource for future processes.

Overview Map: A high level BIM Process Map that illustrates the relationship between BIM Uses which will be employed on the project.

Reference Information: Structured information resources (enterprise and external) that assist or are required to accomplish a BIM Use.

Business Process Mapping Notation (BPMN) Terms and Definitions:

Association: used to tie information and processes with Data Objects. An arrowhead on the Association indicates a direction of flow, when appropriate.

Data Object: a mechanism to show how data is required or produced by activities. They are connected to activities through Associations.

Event: an occurrence the course of a business process. Three types of Events exist, based on when they affect the flow: Start, Intermediate, and End.

Gateway: used to control the divergence and convergence of Sequence Flow. A Gateway can also be seen as equivalent to a decision in conventional flowcharting.

Group: A group represents a category of information. This type of grouping does not affect the Sequence Flow of the activities within the group. The category name appears on the diagram as the group label. Groups can be used for documentation or analysis purposes.

Lane: a sub-partition within a Pool and will extend the entire length of the Pool, either vertically or horizontally. Lanes are used to organize and categorize activities.

Pool: acts as a graphical container for partitioning a set of activities from other Pools.

Process: a generic term for work or activity that entity performs and is represented by a rectangle.

Sequence Flow: used to show the order (predecessors and successors) that activities will be performed in a Process.

APPENDIX K – INDEX

3D Control and Planning	58, 86	Design Authoring	60, 65, 79, 91
3D Coordination	59	Design Reviews	64
3D Design Coordination	84, 91	Design-Build.....	33
4D Modeling.....	21, 67, 76, 91	Detailed BIM Use Process Maps	15, 91
AIA	27, 35, 49, 60	Digital Fabrication	57
Asset Management	49, 51	Disaster Planning	53
AutoDesk.....	68	Energy Analysis	61, 81, 91
BIM Execution Planning Category Guide	119	Energy Modeling.....	61
BIM Execution Planning Process	73	Engineering Analysis	60, 61
BIM Goal Worksheet	10, 47	Existing Conditions Modeling	69, 74
BIM Overview Map.....	15, 16, 17, 18, 19, 91	Information Exchange	5, 8, 19, 23, 24, 37
BIM Process Map.....	38	Information Exchange Worksheet	99
BIM Project Execution Plan.....	2, 6, 37	IPD.....	33, 35
BIM Project Execution Plan Template	101	Lab Example Process Maps	91
BIM Use Analysis Worksheet	70	Lighting Analysis	83
BIM Use Descriptions	48	Maintenance Scheduling.....	88
BIM Uses	4, 9, 10, 12, 13, 29, 37, 38, 47	NBIMS.....	1, 7, 8
BPMN.....	15	Phase Planning.....	67
Building Information Modeling	1, 62, 63	Process Maps.....	5, 6, 15, 19, 29
Building Maintenance Scheduling	49	Programming.....	65, 78
Building Systems Analysis	50, 89	Record Modeling	49, 54, 87, 91
buildingSMART alliance	7	Site Analysis.....	66, 77
Business Process Modeling Notation	15	Site Utilization Planning	55, 85
CM at Risk	34	Space Management and Tracking.....	52
CMMS	49	Structural Analysis	82
ConsensusDOCS	27, 34, 35	Sustainability (LEED) Evaluation	62
Construction System Design	56	Template Process Maps	71
Cost Estimation	68, 75		